



Katalog techniczny i cennik POLSKA 01/2025

Ceny obowiązują od dnia 01.03.2024

grzejniki kolumnowe **Laserline**

comfort delivered by  **VOGEL&NOOT**

SPIS TREŚCI & PRZEGLĄD
TYPÓW



-  długość
-  wysokość
-  zasilanie
-  powrót
-  rozstaw
podłączeń
-  zaślepka
-  odpowietrznik
-  spust
-  ciśnienie pracy
-  ciśnienie próbne
-  temperatura
zasilania
-  podłączenia

Powyższe piktogramy służą jako orientacja
w trakcie korzystania z niniejszego katalogu.



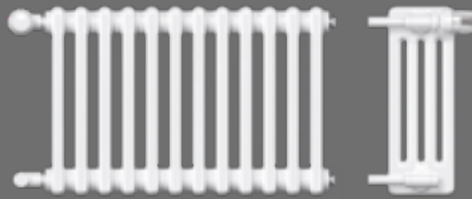

LaserLine Standard

opis techniczny
typy, ceny i wydajności
wskazówki montażowe

04 - 07
08 - 32
33 - 34

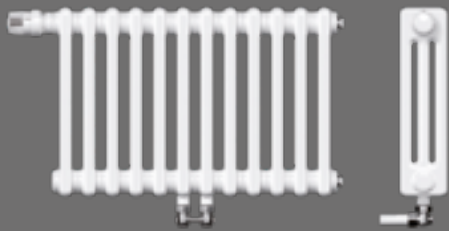

LaserLine Grzejnik zaworowy

opis techniczny
typy, ceny i wydajności

35 - 39
40 - 63

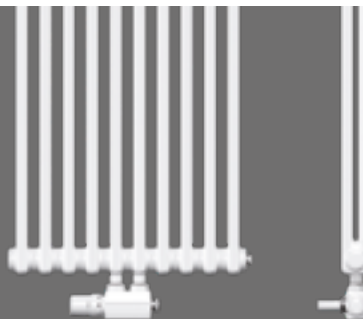

LaserLine Twin

opis techniczny
typy, ceny i wydajności

64
65 - 66

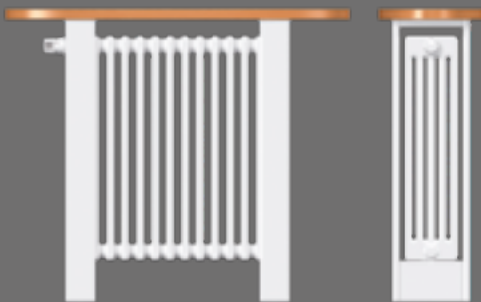

LaserLine Theke

opis techniczny
typy, ceny i wydajności

67
68 - 69



LaserLine Bank

opis techniczny
typy, ceny i wydajności

70
71 - 72

INFORMACJE DODATKOWE

punkty zawieszenia	73 - 75
akcesoria	76 - 79
kody zamówieniowe	80 - 84
paleta kolorów	85

heatingthroughinnovation.

Standard

Grzejnik zaworowy

LaserLine Twin

LaserLine Theke

LaserLine Bank

informacje dodatkowe

LASERLINE STANDARD



wysokość: 155 do 3000 mm
na życzenie Klienta możliwa dostawa
każdej wysokości między 300 a 3000 mm
z dokładnością milimetrową.



długość 200-2500 mm
w zależności od typu i wielkości grzejnika
możliwa dostawa w jednym bloku aż do
długości 2000mm (w tabelach cenowych
zaznaczone na czerwono). W przeciwnym
razie grzejniki dostarczane są w oddzielnych
blokach, łącznie z korkami, nyplami połą-
czeniowymi i uszczelkami.



głębokość
2-kolumnowy 63 mm
3-kolumnowy 101 mm
4-kolumnowy 139 mm
5-kolumnowy 177 mm
6-kolumnowy 215 mm



podłączenie boczne
4 x GW 1/2" (na przedniej
stronie), pasuje również do
rozstawu króćców przyłączeniowych
starych grzejników żeliwnych.



maks. ciśnienie robocze
10 bar



maks. temperatura pracy
110 °C

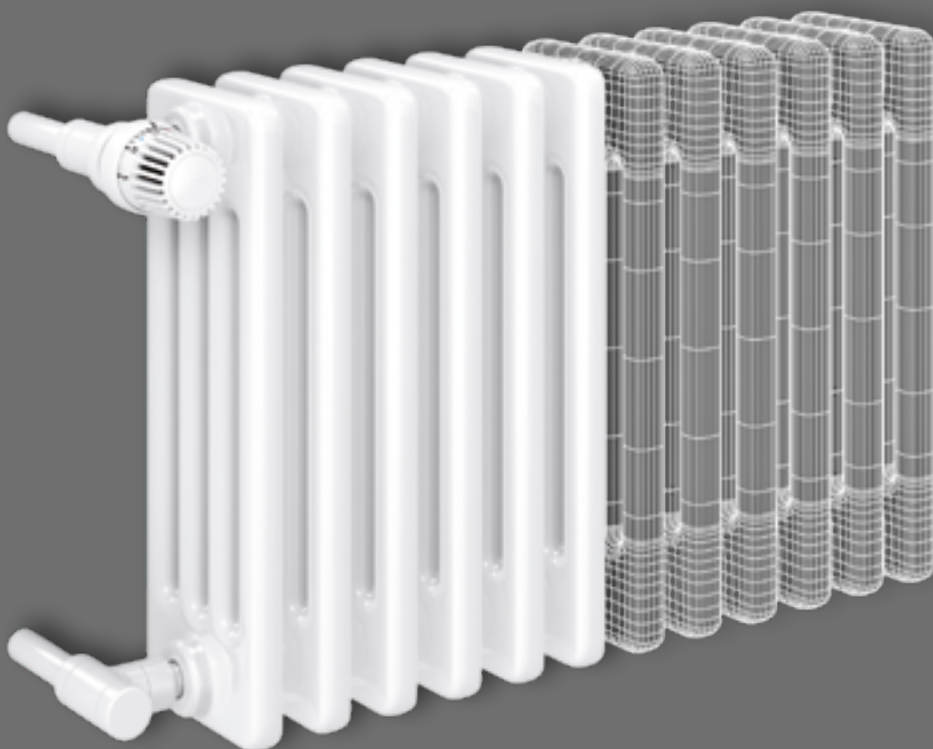

- spawany laserowo - niewidoczne połączenia zgrzewane
- wysoka precyzja produkcji
- optymalne wykonanie ułatwiające czyszczenie

Grzejniki dekoracyjne kolumnowe z precyzyjnej rury stalowej i głowice z kompletnym spawaniem laserowym.

Rury i głowice spłaszczane na stronach zewnętrznych dla podwyższenia mocy cieplnej. Podłączenie zasilania, powrotu, odpowietrznika i spustu łatwo dostępne. Brak nierówności spawalniczych wewnątrz i na zewnątrz grzejnika. Powłoka wstępnie obrobiona, elektroforetycznie gruntowana, pokryta wypalonym proszkiem.

Opakowanie

Nieszkodliwe dla środowiska opakowanie transportowe z kartonową osłoną krawędzi, zgrzewane w folii.

Bezpieczeństwo

Konstrukcja odpowiada wymaganiom BHP. Sprawdzone i zarejestrowane według normy EN 442 nr 6R0900.

Dane techniczne

Króciec o średnicy 1", długość członu 50 mm.

Uwaga!

Tolerancja długości dostarczanych grzejników wynosi 0 do +1 %. Uwzględnić to przy montażu wstępnym!

Wskazówka

Przy grzejnikach kolumnowych LaserLine z gotowych bloków i nypli, zwiększa się wymiar długości o 30 mm. (Każdorazowo 15 mm dla korków gwintowych).

Mocowanie i zakres dostawy

Grzejnik dostarczany jest bez zawieszek i materiałów przyłączeniowych (zobacz akcesoria).

Powłoka

Według DIN 55 900, z elektroforetycznym gruntowaniem i pokryte wypalonym proszkiem w kolorze śnieżnobiałym RAL 9016, inne kolory z palety RAL i kolory specjalne na zapytanie.

przeгляд typów

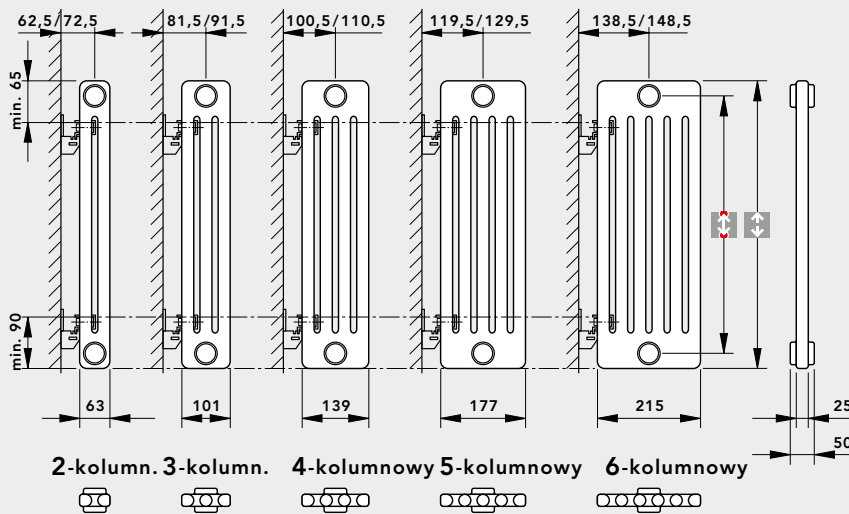
**Wskazówka:**

Grzejniki kolumnowe LaserLine Standard dostarczane są bez mocowań.



rozstaw króćców przyłączeniowych:
wysokość - 65 mm

**wy-
sokość**
[mm]

**rozstaw
króćców**
[mm]

155	90
300	235
350	285
365	300
400	335
415	350
450	385
500	435
550	485
565	500
600	535
665	600
750	685
900	835
965	900
1000	935
1065	1000
1100	1035
1200	1135
1500	1435
1800	1735
2000	1935
2200	2135
2500	2435
2800	2735
3000	2935

maksymalna liczba elementów w jednym bloku

wysokość [mm]	ilość kolumn				
	2	3	4	5	6
155	54	54	54	54	54
300	42	42	42	42	42
350	42	42	42	42	42
365	-	42	42	42	42
400	42	42	42	42	42
415	-	42	42	-	42
450	42	42	42	42	42
500	42	42	42	42	42
550	42	42	42	42	35
565	42	42	42	42	35
600	42	42	42	42	35
665	42	42	42	42	32
750	42	42	42	37	28
900	42	42	32	26	24
965	42	42	32	-	22
1000	42	42	32	26	22
1065	-	19	19	19	19
1100	19	19	19	19	19
1200	19	19	19	19	19
1500	19	19	19	18	15
1800	19	19	19	16	13
2000	19	19	18	14	11
2200	19	19	16	12	10
2500	16	16	14	11	9
2800	16	16	12	10	8
3000	16	16	11	9	8

WAŻNE: Przy zamówieniu grzejnika LaserLine Standard o większej liczbie elementów w danym bloku, niż podano w tabeli, dostawa będzie podzielona na 2 lub więcej bloków, które należy zamontować na miejscu budowy u klienta. Złączki i uszczelki dostarczane są razem z blokami bez dopłaty. Do skręcenia bloków wymagany jest odpowiedni klucz do nypli, patrz strona 78, który należy zamówić osobno!

sposoby podłączeń

Grzejniki kolumnowe LaserLine wyposażone są standardowo w podłączenia z gwintem wewnętrznym GW 1/2":

podłączenie boczne jednostronne

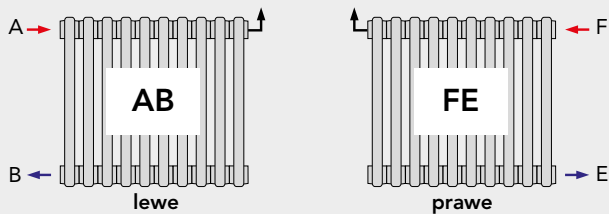

podłączenie boczne krzyżowe

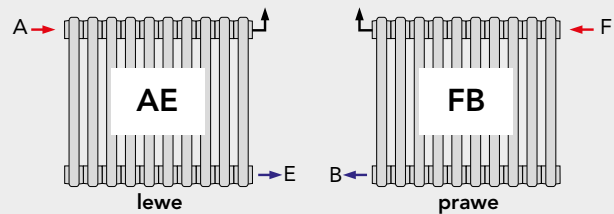

podłączenie dolne; 1 i 2 element

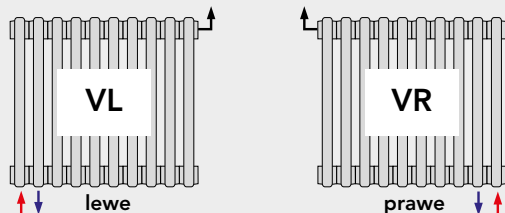

podłączenie dolne; 1 i ostatni element

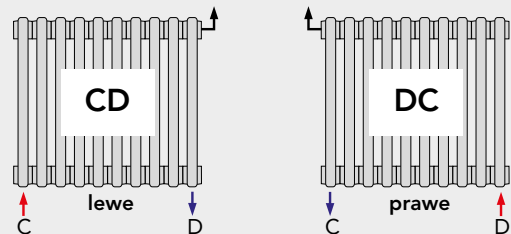
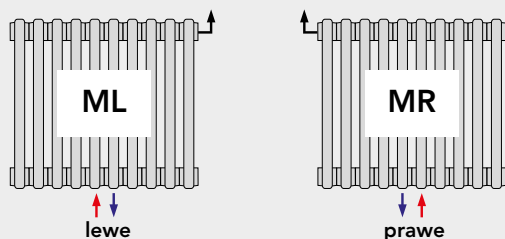
podłączenie dolne; środkowe
tylko parzysta ilość elementów!**Wskazówka**

W zamówieniu należy koniecznie podać wariant podłączenia!

przykład

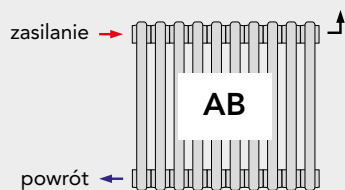
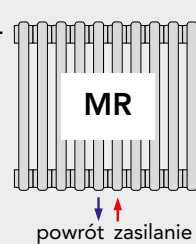
wariant podłączenia AB
(jednostronne, lewe)wariant podłączenia MR
(środkowe, prawe)

ΔT - różnica temperatur między grzejnikiem a otoczeniem.

temp. zasilania t_1 °C	temp. powietrza w pomieszczeniu t_r °C	temp. powrotu t_2 °C						
		70	65	60	55	50	45	40
90	15	65	62	59	56	53	50	46
	18	62	59	56	53	50	46	43
	20	60	57	54	51	48	44	40
	22	58	55	52	49	46	42	38
	24	56	53	50	47	43	40	36
85	15	63	60	57	54	51	48	44
	18	60	57	54	51	48	44	41
	20	58	55	52	49	46	42	39
	22	56	53	50	47	44	40	36
	24	54	51	48	45	41	38	34
80	15	60	58	55	52	49	46	42
	18	57	55	52	49	46	42	39
	20	55	53	50	47	44	40	37
	22	53	51	48	45	42	38	35
	24	51	49	46	43	39	36	32
75	15	58	55	53	50	47	44	40
	18	55	52	50	47	44	41	37
	20	53	50	48	45	42	38	35
	22	51	48	46	43	40	36	33
	24	49	46	44	41	37	34	30
70	15	-	53	50	48	45	42	38
	18	-	50	47	45	42	39	35
	20	-	48	45	43	40	36	33
	22	-	46	43	40	37	34	31
	24	-	44	41	38	35	32	29
65	15	-	-	48	45	43	40	36
	18	-	-	45	42	39	36	33
	20	-	-	43	40	37	34	31
	22	-	-	41	38	35	32	29
	24	-	-	39	36	33	30	27
60	15	-	-	-	43	40	37	34
	18	-	-	-	40	37	34	31
	20	-	-	-	38	35	32	29
	22	-	-	-	36	33	30	27
	24	-	-	-	34	31	28	25
55	15	-	-	-	-	38	35	32
	18	-	-	-	-	35	32	29
	20	-	-	-	-	33	30	27
	22	-	-	-	-	31	28	25
	24	-	-	-	-	29	26	23
50	15	-	-	-	-	-	33	30
	18	-	-	-	-	-	30	27
	20	-	-	-	-	-	28	25
	22	-	-	-	-	-	26	23
	24	-	-	-	-	-	24	21

współczynnik przeliczeniowy U_f

Współczynnik przeliczeniowy U_f mocy cieplnej przy innym ΔT niż 50 K.

ΔT K	U_f	ΔT K	U_f
65	1,408	43	0,821
64	1,380	42	0,796
63	1,352	41	0,771
62	1,324	40	0,747
61	1,296	39	0,723
60	1,268	38	0,699
59	1,241	37	0,675
58	1,213	36	0,651
57	1,186	35	0,627
56	1,159	34	0,604
55	1,132	33	0,581
54	1,105	32	0,558
53	1,079	31	0,535
52	1,052	30	0,513
51	1,026	29	0,491
50	1,--0	28	0,469
49	0,974	27	0,447
48	0,948	26	0,426
47	0,922	25	0,404
46	0,897	24	0,383
45	0,871	23	0,363
44	0,846	22	0,342
43	0,821	21	0,322
44	0,796		

Moc cieplna wg DIN EN 442

przy $t_1 = 75^\circ \text{C}$, $t_2 = 65^\circ \text{C}$, $t_r = 20^\circ \text{C}$
Dla innego ΔT będzie ten współczynnik użyty jak wyżej przedstawiono

przykład

Grzejnik kolumnowy LaserLine model 6050, 10 członów, moc cieplna przy $\Delta T = 50 \text{ K}$:
 $103,76 \text{ W/człon} \cdot 10 \text{ członów} = 1037,6 \text{ W}$.

Przy zasilaniu 70°C , powrocie 55°C , temperaturze powietrza w pomieszczeniu 18°C równa się $\Delta T = 45 \text{ K}$ (patrz tabela na lewo).

Współczynnik przeliczeniowy $U_f = 0,871$ (patrz tabela u góry).

Faktyczna moc cieplna:
 $1037,6 \cdot 0,871 = 903,75 \text{ W}$.

08 LASERLINE STANDARD

Ceny i wydajność cieplna

Product Class D12000 Item Group OOD90A ETIM Class EC003539

dane techniczne / ceny netto											
Uwaga! montaż grzejnika możliwy wyłącznie za pomocą zawieszek WK155 lub stojaków FK5. Ceny nie zawierają zamocowań. Niebieskie ceny: dostawa możliwa w jednym bloku.											
wysokość [mm] 155	2-kolumnowy 63 mm		3-kolumnowy 101 mm		4-kolumnowy 139 mm		5-kolumnowy 177 mm		6-kolumnowy 215 mm		
	rozstaw króćców 90 mm 	typ	2016		3016		4016		5016		6016
wykładnik n	1,2120		1,2227		1,2222		1,2413		1,2359		
poj. wody/człon w l	0,27		0,39		0,51		0,63		0,75		
waga/człon w kg	0,30		0,45		0,61		0,76		0,93		
człony długość [mm]	[W]	PLN	[W]	PLN	[W]	PLN	[W]	PLN	[W]	PLN	
	4	200	51	446	70	479	91	544	115	649	139
5	250	63	558	88	598	114	679	144	811	174	943
6	300	76	670	105	718	137	815	172	974	209	1132
7	350	89	781	123	838	160	951	201	1136	244	1321
8	400	101	893	140	957	183	1087	230	1298	278	1509
9	450	114	1004	158	1077	205	1223	258	1461	313	1698
10	500	127	1116	175	1197	228	1359	287	1623	348	1887
11	550	139	1227	193	1316	251	1495	316	1785	383	2075
12	600	152	1339	210	1436	274	1631	345	1947	418	2264
13	650	165	1451	228	1556	297	1767	373	2110	452	2452
14	700	177	1562	245	1675	320	1902	402	2272	487	2641
15	750	190	1674	263	1795	342	2038	431	2434	522	2830
16	800	203	1785	280	1915	365	2174	459	2596	557	3018
17	850	215	1897	298	2034	388	2310	488	2759	592	3207
18	900	228	2009	315	2154	411	2446	517	2921	626	3396
19	950	241	2120	333	2274	434	2582	545	3083	661	3584
20	1000	253	2232	350	2393	457	2718	574	3246	696	3773
21	1050	266	2343	368	2513	479	2854	603	3408	731	3962
22	1100	279	2455	385	2633	502	2990	632	3570	766	4150
23	1150	291	2567	403	2752	525	3125	660	3732	800	4339
24	1200	304	2678	420	2872	548	3261	689	3895	835	4528
25	1250	317	2790	438	2992	571	3397	718	4057	870	4716
26	1300	329	2901	455	3111	594	3533	746	4219	905	4905
27	1350	342	3013	473	3231	616	3669	775	4382	940	5094
28	1400	354	3125	490	3351	639	3805	804	4544	974	5282
29	1450	367	3236	508	3470	662	3941	833	4706	1009	5471
30	1500	380	3348	525	3590	685	4077	861	4868	1044	5660
31	1550	392	3459	543	3710	708	4213	890	5031	1079	5848
32	1600	405	3571	560	3829	731	4348	919	5193	1114	6037
33	1650	418	3682	578	3949	753	4484	947	5355	1148	6225
34	1700	430	3794	595	4069	776	4620	976	5518	1183	6414
35	1750	443	3906	613	4188	799	4756	1005	5680	1218	6603
36	1800	456	4017	630	4308	822	4892	1034	5842	1253	6791
37	1850	468	4129	648	4428	845	5028	1062	6004	1288	6980
38	1900	481	4240	665	4547	868	5164	1091	6167	1322	7169
39	1950	494	4352	683	4667	890	5300	1120	6329	1357	7357
40	2000	506	4464	700	4787	913	5436	1148	6491	1392	7546
41	2050	519	4575	718	4906	936	5571	1177	6653	1427	7735
42	2100	532	4687	735	5026	959	5707	1206	6816	1462	7923
43	2150	544	4798	753	5146	982	5843	1235	6978	1496	8112
44	2200	557	4910	770	5265	1005	5979	1263	7140	1531	8301
45	2250	570	5022	788	5385	1027	6115	1292	7303	1566	8489
46	2300	582	5133	805	5505	1050	6251	1321	7465	1601	8678
47	2350	595	5245	823	5624	1073	6387	1349	7627	1636	8867
48	2400	608	5356	840	5744	1096	6523	1378	7789	1670	9055
49	2450	620	5468	858	5864	1119	6659	1407	7952	1705	9244
50	2500	633	5580	876	5984	1142	6795	1436	8114	1740	9433

Moc cieplna grzejników [W] wg normy EN 442 dla parametrów 75/65/20 °C. PKWU 25.21.11.0; CN 2020 7322 1900. Ceny netto w zł bez podatku VAT.

Product Class D12000 Item Group OOD90A ETIM Class ECO03539

dane techniczne / ceny netto

Ceny nie zawierają zamocowań. **Niebieskie ceny:** dostawa możliwa w jednym bloku.

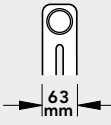
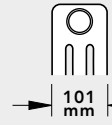
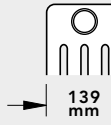
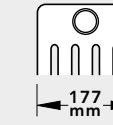
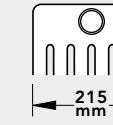
wysokość [mm]		2-kolumnowy		3-kolumnowy		4-kolumnowy		5-kolumnowy		6-kolumnowy	
300											
rozstaw króćców 235 mm											
typ		2030		3030		4030		5030		6030	
wyktadnik n		1,2243		1,2270		1,2297		1,2410		1,2523	
poj. wody/człon w l		0,40		0,57		0,75		0,93		1,11	
waga/człon w kg		0,52		0,78		1,05		1,30		1,57	
człony	długość [mm]	[W]		[W]		[W]		[W]		[W]	
			PLN		PLN		PLN		PLN		PLN
4	200	101	454	142	495	182	552	224	657	266	763
5	250	126	568	177	619	228	690	280	822	332	953
6	300	151	681	212	742	273	828	336	986	398	1144
7	350	177	795	248	866	319	966	392	1150	465	1335
8	400	202	909	283	990	364	1104	448	1314	531	1525
9	450	227	1022	319	1114	410	1242	504	1479	598	1716
10	500	252	1136	354	1237	456	1380	560	1643	664	1907
11	550	278	1249	389	1361	501	1517	616	1807	730	2097
12	600	303	1363	425	1485	547	1655	672	1972	797	2288
13	650	328	1476	460	1608	592	1793	728	2136	863	2479
14	700	353	1590	496	1732	638	1931	784	2300	929	2669
15	750	379	1704	531	1856	683	2069	840	2465	996	2860
16	800	404	1817	566	1980	729	2207	896	2629	1062	3051
17	850	429	1931	602	2103	775	2345	952	2793	1129	3241
18	900	454	2044	637	2227	820	2483	1008	2957	1195	3432
19	950	480	2158	673	2351	866	2621	1064	3122	1261	3623
20	1000	505	2271	708	2475	911	2759	1120	3286	1328	3813
21	1050	530	2385	743	2598	957	2897	1176	3450	1394	4004
22	1100	555	2499	779	2722	1002	3035	1232	3615	1461	4195
23	1150	581	2612	814	2846	1048	3173	1288	3779	1527	4385
24	1200	606	2726	850	2970	1093	3311	1344	3943	1593	4576
25	1250	631	2839	885	3093	1139	3449	1400	4108	1660	4767
26	1300	656	2953	920	3217	1185	3587	1455	4272	1726	4957
27	1350	681	3066	956	3341	1230	3725	1511	4436	1793	5148
28	1400	707	3180	991	3464	1276	3863	1567	4600	1859	5339
29	1450	732	3294	1027	3588	1321	4001	1623	4765	1925	5529
30	1500	757	3407	1062	3712	1367	4139	1679	4929	1992	5720
31	1550	782	3521	1097	3836	1412	4276	1735	5093	2058	5911
32	1600	808	3634	1133	3959	1458	4414	1791	5258	2124	6101
33	1650	833	3748	1168	4083	1503	4552	1847	5422	2191	6292
34	1700	858	3861	1204	4207	1549	4690	1903	5586	2257	6483
35	1750	883	3975	1239	4331	1595	4828	1959	5751	2324	6673
36	1800	909	4089	1274	4454	1640	4966	2015	5915	2390	6864
37	1850	934	4202	1310	4578	1686	5104	2071	6079	2456	7055
38	1900	959	4316	1345	4702	1731	5242	2127	6243	2523	7245
39	1950	984	4429	1381	4825	1777	5380	2183	6408	2589	7436
40	2000	1010	4543	1416	4949	1822	5518	2239	6572	2656	7627
41	2050	1035	4656	1451	5073	1868	5656	2295	6736	2722	7817
42	2100	1060	4770	1487	5197	1914	5794	2351	6901	2788	8008
43	2150	1085	4884	1522	5320	1959	5932	2407	7065	2855	8199
44	2200	1111	4997	1558	5444	2005	6070	2463	7229	2921	8389
45	2250	1136	5111	1593	5568	2050	6208	2519	7394	2988	8580
46	2300	1161	5224	1628	5692	2096	6346	2575	7558	3054	8771
47	2350	1186	5338	1664	5815	2141	6484	2631	7722	3120	8961
48	2400	1212	5451	1699	5939	2187	6622	2687	7886	3187	9152
49	2450	1237	5565	1735	6063	2232	6760	2743	8051	3253	9343
50	2500	1262	5679	1770	6187	2278	6898	2799	8215	3320	9534

Standard

10 LASERLINE STANDARD

Ceny i wydajność cieplna

Product Class D12000 Item Group OOD90A ETIM Class EC003539

dane techniczne / ceny netto											
Ceny nie zawierają zamocowań. Niebieskie ceny : dostawa możliwa w jednym bloku.											
wysokość [mm] 350	2-kolumnowy		3-kolumnowy		4-kolumnowy		5-kolumnowy		6-kolumnowy		
	63 mm		101 mm		139 mm		177 mm		215 mm		
rozstaw króćców 285 mm											
typ	2035		3035		4035		5035		6035		
wykładnik n	1,2269		1,2330		1,2390		1,2488		1,2585		
poj. wody/człon w l	0,44		0,64		0,84		1,03		1,23		
waga/człon w kg	0,60		0,89		1,20		1,49		1,86		
człony dtu-gość [mm]	[W]	PLN	[W]	PLN	[W]	PLN	[W]	PLN	[W]	PLN	
4	200	116	462	162	503	208	568	256	673	304	787
5	250	145	578	203	629	260	710	320	842	380	984
6	300	174	694	243	755	312	852	384	1010	456	1181
7	350	203	809	284	880	364	994	448	1178	532	1377
8	400	232	925	324	1006	416	1136	512	1347	607	1574
9	450	261	1041	365	1132	468	1278	576	1515	683	1771
10	500	290	1156	405	1258	520	1420	640	1684	759	1968
11	550	319	1272	446	1383	572	1562	704	1852	835	2164
12	600	348	1387	486	1509	624	1704	768	2020	911	2361
13	650	376	1503	527	1635	677	1846	832	2189	987	2558
14	700	405	1619	567	1761	729	1988	896	2357	1063	2755
15	750	434	1734	608	1886	781	2130	960	2525	1139	2951
16	800	463	1850	648	2012	833	2272	1024	2694	1215	3148
17	850	492	1966	689	2138	885	2414	1088	2862	1291	3345
18	900	521	2081	729	2264	937	2556	1152	3030	1367	3542
19	950	550	2197	770	2389	989	2698	1216	3199	1443	3738
20	1000	579	2312	810	2515	1041	2840	1280	3367	1519	3935
21	1050	608	2428	851	2641	1093	2982	1344	3535	1595	4132
22	1100	637	2544	891	2767	1145	3124	1408	3704	1670	4329
23	1150	666	2659	932	2892	1197	3266	1472	3872	1746	4525
24	1200	695	2775	972	3018	1249	3408	1536	4040	1822	4722
25	1250	724	2891	1013	3144	1301	3550	1600	4209	1898	4919
26	1300	753	3006	1053	3270	1353	3692	1664	4377	1974	5116
27	1350	782	3122	1094	3396	1405	3834	1728	4545	2050	5313
28	1400	811	3237	1134	3521	1457	3976	1792	4714	2126	5509
29	1450	840	3353	1175	3647	1509	4118	1856	4882	2202	5706
30	1500	869	3469	1215	3773	1561	4260	1920	5051	2278	5903
31	1550	898	3584	1256	3899	1613	4402	1984	5219	2354	6100
32	1600	927	3700	1296	4024	1665	4544	2048	5387	2430	6296
33	1650	956	3815	1337	4150	1717	4686	2112	5556	2506	6493
34	1700	985	3931	1377	4276	1769	4828	2176	5724	2582	6690
35	1750	1014	4047	1418	4402	1821	4970	2240	5892	2658	6887
36	1800	1043	4162	1458	4527	1873	5112	2304	6061	2733	7083
37	1850	1072	4278	1499	4653	1925	5254	2368	6229	2809	7280
38	1900	1100	4394	1539	4779	1978	5396	2432	6397	2885	7477
39	1950	1129	4509	1580	4905	2030	5538	2496	6566	2961	7674
40	2000	1158	4625	1620	5030	2082	5680	2560	6734	3037	7870
41	2050	1187	4740	1661	5156	2134	5822	2624	6902	3113	8067
42	2100	1216	4856	1701	5282	2186	5964	2688	7071	3189	8264
43	2150	1245	4972	1742	5408	2238	6106	2752	7239	3265	8461
44	2200	1274	5087	1782	5533	2290	6248	2816	7407	3341	8657
45	2250	1303	5203	1823	5659	2342	6390	2880	7576	3417	8854
46	2300	1332	5319	1863	5785	2394	6532	2944	7744	3493	9051
47	2350	1361	5434	1904	5911	2446	6674	3008	7912	3569	9248
48	2400	1390	5550	1944	6036	2498	6816	3072	8081	3645	9444
49	2450	1419	5665	1985	6162	2550	6958	3136	8249	3721	9641
50	2500	1448	5781	2025	6288	2602	7101	3200	8418	3797	9838

Moc cieplna grzejników [W] wg normy EN 442 dla parametrów 75/65/20 °C. PKWiU 25.21.11.0; CN 2020 7322 1900. Ceny netto w zł bez podatku VAT.

Product Class D12000 Item Group OOD90A ETIM Class ECO03539

dane techniczne / ceny netto

Ceny nie zawierają zamocowań. **Niebieskie ceny:** dostawa możliwa w jednym bloku.

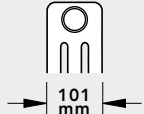
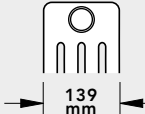
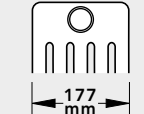
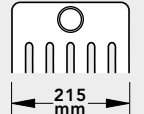

wysokość [mm]				3-kolumnowy		4-kolumnowy		5-kolumnowy		6-kolumnowy	
365											
rozstaw króćców 300 mm				101 mm		139 mm		177 mm		215 mm	
typ				3037		4037		5037		6037	
wyktadnik n				1,2347		1,2417		1,2510		1,2603	
poj. wody/człon w l				0,66		0,86		1,06		1,27	
waga/człon w kg				0,91		1,22		1,54		1,86	
człony	długość [mm]	[W]	PLN	[W]	PLN	[W]	PLN	[W]	PLN	[W]	PLN
		4	200			168	511	216	576	265	682
5	250			210	639	270	720	332	852	394	994
6	300			252	767	324	864	398	1022	473	1193
7	350			294	895	378	1008	465	1193	551	1392
8	400			336	1022	432	1152	531	1363	630	1590
9	450			378	1150	486	1296	597	1533	709	1789
10	500			420	1278	540	1440	664	1704	788	1988
11	550			462	1406	594	1584	730	1874	866	2187
12	600			504	1533	648	1728	796	2045	945	2385
13	650			546	1661	701	1872	863	2215	1024	2584
14	700			588	1789	755	2016	929	2385	1103	2783
15	750			630	1917	809	2160	995	2556	1181	2982
16	800			672	2045	863	2304	1062	2726	1260	3181
17	850			714	2172	917	2448	1128	2896	1339	3379
18	900			756	2300	971	2592	1194	3067	1418	3578
19	950			798	2428	1025	2736	1261	3237	1496	3777
20	1000			840	2556	1079	2880	1327	3408	1575	3976
21	1050			882	2684	1133	3024	1394	3578	1654	4175
22	1100			924	2811	1187	3168	1460	3748	1733	4373
23	1150			966	2939	1241	3312	1526	3919	1811	4572
24	1200			1008	3067	1295	3456	1593	4089	1890	4771
25	1250			1050	3195	1349	3600	1659	4260	1969	4970
26	1300			1092	3323	1403	3744	1725	4430	2048	5169
27	1350			1134	3450	1457	3888	1792	4600	2127	5367
28	1400			1176	3578	1511	4032	1858	4771	2205	5566
29	1450			1218	3706	1565	4176	1924	4941	2284	5765
30	1500			1260	3834	1619	4320	1991	5111	2363	5964
31	1550			1302	3961	1673	4464	2057	5282	2442	6162
32	1600			1344	4089	1727	4608	2124	5452	2520	6361
33	1650			1386	4217	1781	4752	2190	5623	2599	6560
34	1700			1428	4345	1835	4896	2256	5793	2678	6759
35	1750			1470	4473	1889	5040	2323	5963	2757	6958
36	1800			1512	4600	1943	5184	2389	6134	2835	7156
37	1850			1554	4728	1997	5328	2455	6304	2914	7355
38	1900			1596	4856	2050	5472	2522	6474	2993	7554
39	1950			1638	4984	2104	5616	2588	6645	3072	7753
40	2000			1680	5112	2158	5760	2654	6815	3150	7952
41	2050			1722	5239	2212	5904	2721	6986	3229	8150
42	2100			1764	5367	2266	6048	2787	7156	3308	8349
43	2150			1806	5495	2320	6192	2853	7326	3387	8548
44	2200			1848	5623	2374	6336	2920	7497	3465	8747
45	2250			1890	5751	2428	6480	2986	7667	3544	8946
46	2300			1932	5878	2482	6624	3053	7837	3623	9144
47	2350			1974	6006	2536	6768	3119	8008	3702	9343
48	2400			2016	6134	2590	6912	3185	8178	3780	9542
49	2450			2058	6262	2644	7056	3252	8349	3859	9741
50	2500			2101	6390	2698	7201	3318	8519	3938	9940

Standard

12 LASERLINE STANDARD

Ceny i wydajność cieplna

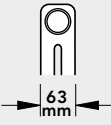
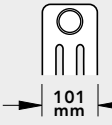
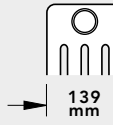
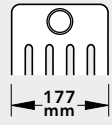
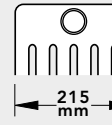
Product Class D12000 Item Group OOD90A ETIM Class EC003539



dane techniczne / ceny netto											
Ceny nie zawierają zamocowań. Niebieskie ceny dostawa możliwa w jednym bloku.											
 wysokość [mm] 400	2-kolumnowy		3-kolumnowy		4-kolumnowy		5-kolumnowy		6-kolumnowy		
	 63 mm		 101 mm		 139 mm		 177 mm		 215 mm		
 rozstaw króćców 335 mm	2040		3040		4040		5040		6040		
typ	1,2296		1,2388		1,2479		1,2562		1,2645		
wykładnik n	0,49		0,70		0,92		1,14		1,35		
poj. wody/człon w l	0,68		1,00		1,35		1,67		2,02		
waga/człon w kg	0,68		1,00		1,35		1,67		2,02		
człony  dtu- gość [mm]	[W]	PLN	[W]	PLN	[W]	PLN	[W]	PLN	[W]	PLN	
	4	200	131	471	182	519	234	584	287	682	341
5	250	163	588	228	649	292	730	359	852	427	1024
6	300	196	706	273	779	350	876	431	1022	512	1229
7	350	228	824	319	909	409	1022	503	1193	597	1434
8	400	261	941	364	1039	467	1168	575	1363	683	1639
9	450	294	1059	410	1168	526	1314	647	1533	768	1844
10	500	326	1177	455	1298	584	1461	719	1704	853	2049
11	550	359	1294	501	1428	642	1607	791	1874	939	2254
12	600	392	1412	546	1558	701	1753	862	2045	1024	2458
13	650	424	1529	592	1688	759	1899	934	2215	1109	2663
14	700	457	1647	637	1817	818	2045	1006	2385	1195	2868
15	750	489	1765	683	1947	876	2191	1078	2556	1280	3073
16	800	522	1882	728	2077	934	2337	1150	2726	1365	3278
17	850	555	2000	774	2207	993	2483	1222	2896	1451	3483
18	900	587	2118	819	2337	1051	2629	1294	3067	1536	3688
19	950	620	2235	865	2467	1110	2775	1366	3237	1621	3893
20	1000	653	2353	910	2596	1168	2921	1437	3408	1707	4097
21	1050	685	2471	956	2726	1226	3067	1509	3578	1792	4302
22	1100	718	2588	1001	2856	1285	3213	1581	3748	1877	4507
23	1150	750	2706	1047	2986	1343	3359	1653	3919	1963	4712
24	1200	783	2824	1092	3116	1402	3505	1725	4089	2048	4917
25	1250	816	2941	1138	3246	1460	3651	1797	4260	2133	5122
26	1300	848	3059	1184	3375	1518	3797	1869	4430	2219	5327
27	1350	881	3177	1229	3505	1577	3943	1940	4600	2304	5531
28	1400	914	3294	1275	3635	1635	4089	2012	4771	2389	5736
29	1450	946	3412	1320	3765	1694	4235	2084	4941	2475	5941
30	1500	979	3530	1366	3895	1752	4382	2156	5111	2560	6146
31	1550	1012	3647	1411	4024	1810	4528	2228	5282	2645	6351
32	1600	1044	3765	1457	4154	1869	4674	2300	5452	2731	6556
33	1650	1077	3882	1502	4284	1927	4820	2372	5623	2816	6761
34	1700	1109	4000	1548	4414	1986	4966	2444	5793	2901	6966
35	1750	1142	4118	1593	4544	2044	5112	2515	5963	2987	7170
36	1800	1175	4235	1639	4674	2102	5258	2587	6134	3072	7375
37	1850	1207	4353	1684	4803	2161	5404	2659	6304	3157	7580
38	1900	1240	4471	1730	4933	2219	5550	2731	6474	3243	7785
39	1950	1273	4588	1775	5063	2278	5696	2803	6645	3328	7990
40	2000	1305	4706	1821	5193	2336	5842	2875	6815	3413	8195
41	2050	1338	4824	1866	5323	2394	5988	2947	6986	3499	8400
42	2100	1370	4941	1912	5452	2453	6134	3019	7156	3584	8605
43	2150	1403	5059	1957	5582	2511	6280	3090	7326	3669	8809
44	2200	1436	5177	2003	5712	2570	6426	3162	7497	3755	9014
45	2250	1468	5294	2048	5842	2628	6572	3234	7667	3840	9219
46	2300	1501	5412	2094	5972	2686	6718	3306	7837	3925	9424
47	2350	1534	5530	2139	6102	2745	6864	3378	8008	4011	9629
48	2400	1566	5647	2185	6231	2803	7010	3450	8178	4096	9834
49	2450	1599	5765	2230	6361	2862	7156	3522	8349	4181	10039
50	2500	1632	5883	2276	6491	2920	7303	3594	8519	4267	10244

Moc cieplna grzejników [W] wg normy EN 442 dla parametrów 75/65/20 °C. PKWiU 25.21.11.0; CN 2020 7322 1900. Ceny netto w zł bez podatku VAT.



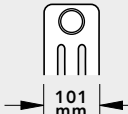
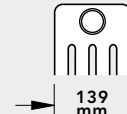
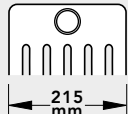

Product Class D12000 Item Group OOD90A ETIM Class ECO03539

dane techniczne / ceny netto

Ceny nie zawierają zamocowań. **Niebieskie ceny:** dostawa możliwa w jednym bloku.

wysokość [mm]				3-kolumnowy		4-kolumnowy				6-kolumnowy	
 415											
rozstaw króćców 350 mm				101 mm		139 mm				215 mm	
typ				3042		4042				6042	
wyktadnik n				1,2405		1,2505				1,2663	
poj. wody/człon w l				0,72		0,95				1,39	
waga/człon w kg				1,03		1,37				2,08	
człony	 dtu- gość [mm]	[W]	PLN	[W]		[W]		[W]		[W]	
				PLN	PLN	PLN	PLN	PLN	PLN		
4	200			188	527	241	600			352	819
5	250			235	659	301	750			441	1024
6	300			282	791	362	901			529	1229
7	350			329	923	422	1051			617	1434
8	400			376	1055	482	1201			705	1639
9	450			423	1187	543	1351			793	1844
10	500			470	1319	603	1501			881	2049
11	550			517	1450	663	1651			969	2254
12	600			564	1582	723	1801			1057	2458
13	650			611	1714	784	1951			1146	2663
14	700			658	1846	844	2101			1234	2868
15	750			705	1978	904	2251			1322	3073
16	800			752	2110	965	2401			1410	3278
17	850			799	2241	1025	2552			1498	3483
18	900			846	2373	1085	2702			1586	3688
19	950			893	2505	1146	2852			1674	3893
20	1000			940	2637	1206	3002			1762	4097
21	1050			987	2769	1266	3152			1851	4302
22	1100			1034	2901	1326	3302			1939	4507
23	1150			1081	3033	1387	3452			2027	4712
24	1200			1128	3164	1447	3602			2115	4917
25	1250			1175	3296	1507	3752			2203	5122
26	1300			1222	3428	1568	3902			2291	5327
27	1350			1269	3560	1628	4052			2379	5531
28	1400			1316	3692	1688	4203			2467	5736
29	1450			1363	3824	1748	4353			2555	5941
30	1500			1410	3956	1809	4503			2644	6146
31	1550			1457	4087	1869	4653			2732	6351
32	1600			1504	4219	1929	4803			2820	6556
33	1650			1551	4351	1990	4953			2908	6761
34	1700			1598	4483	2050	5103			2996	6966
35	1750			1645	4615	2110	5253			3084	7170
36	1800			1692	4747	2170	5403			3172	7375
37	1850			1739	4878	2231	5553			3260	7580
38	1900			1786	5010	2291	5703			3349	7785
39	1950			1833	5142	2351	5854			3437	7990
40	2000			1880	5274	2412	6004			3525	8195
41	2050			1927	5406	2472	6154			3613	8400
42	2100			1974	5538	2532	6304			3701	8605
43	2150			2021	5670	2592	6454			3789	8809
44	2200			2068	5801	2653	6604			3877	9014
45	2250			2115	5933	2713	6754			3965	9219
46	2300			2162	6065	2773	6904			4054	9424
47	2350			2209	6197	2834	7054			4142	9629
48	2400			2256	6329	2894	7204			4230	9834
49	2450			2303	6461	2954	7354			4318	10039
50	2500			2351	6593	3015	7505			4406	10244

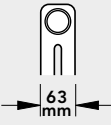
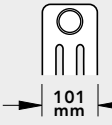
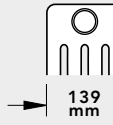
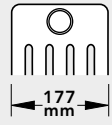
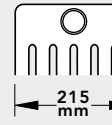
Moc cieplna grzejników [W] wg normy EN 442 dla parametrów 75/65/20 °C. PKWIU 25.21.11.0; CN 2020 7322 1900. Ceny netto w zł bez podatku VAT.

dane techniczne / ceny netto											
Ceny nie zawierają zamocowań. Niebieskie ceny : dostawa możliwa w jednym bloku.											
 wysokość [mm] 450	2-kolumnowy		3-kolumnowy		4-kolumnowy		5-kolumnowy		6-kolumnowy		
	 rozstaw króćców 385 mm	 63 mm		 101 mm		 139 mm		 177 mm		 215 mm	
typ	2045		3045		4045		5045		6045		
wyktadnik n	1,2325		1,2445		1,2564		1,2634		1,2703		
poj. wody/człon w l	0,53		0,76		1,01		1,24		1,48		
waga/człon w kg	0,75		1,12		1,49		1,86		2,24		
człony  długość [mm]	[W]	PLN	[W]	PLN	[W]	PLN	[W]	PLN	[W]	PLN	
	4	200	145	487	202	544	259	608	319	714	378
5	250	181	608	252	679	323	761	398	893	473	1035
6	300	218	730	303	815	388	913	478	1071	568	1241
7	350	254	852	353	951	453	1065	557	1250	662	1448
8	400	290	974	404	1087	517	1217	637	1428	757	1655
9	450	326	1095	454	1223	582	1369	717	1607	851	1862
10	500	363	1217	505	1359	647	1521	796	1785	946	2069
11	550	399	1339	555	1495	711	1673	876	1964	1041	2276
12	600	435	1460	606	1631	776	1825	956	2142	1135	2483
13	650	471	1582	656	1767	841	1978	1035	2321	1230	2690
14	700	508	1704	707	1902	906	2130	1115	2499	1324	2897
15	750	544	1825	757	2038	970	2282	1195	2678	1419	3104
16	800	580	1947	808	2174	1035	2434	1274	2856	1514	3310
17	850	616	2069	858	2310	1100	2586	1354	3035	1608	3517
18	900	653	2190	908	2446	1164	2738	1434	3213	1703	3724
19	950	689	2312	959	2582	1229	2890	1513	3392	1797	3931
20	1000	725	2434	1009	2718	1294	3042	1593	3570	1892	4138
21	1050	761	2555	1060	2854	1358	3195	1672	3749	1987	4345
22	1100	798	2677	1110	2990	1423	3347	1752	3927	2081	4552
23	1150	834	2799	1161	3125	1488	3499	1832	4106	2176	4759
24	1200	870	2921	1211	3261	1552	3651	1911	4284	2270	4966
25	1250	907	3042	1262	3397	1617	3803	1991	4463	2365	5173
26	1300	943	3164	1312	3533	1682	3955	2071	4641	2460	5379
27	1350	979	3286	1363	3669	1746	4107	2150	4820	2554	5586
28	1400	1015	3407	1413	3805	1811	4259	2230	4998	2649	5793
29	1450	1052	3529	1464	3941	1876	4411	2310	5177	2743	6000
30	1500	1088	3651	1514	4077	1940	4564	2389	5355	2838	6207
31	1550	1124	3772	1565	4213	2005	4716	2469	5534	2933	6414
32	1600	1160	3894	1615	4348	2070	4868	2548	5712	3027	6621
33	1650	1197	4016	1666	4484	2134	5020	2628	5891	3122	6828
34	1700	1233	4137	1716	4620	2199	5172	2708	6069	3216	7035
35	1750	1269	4259	1766	4756	2264	5324	2787	6248	3311	7242
36	1800	1305	4381	1817	4892	2328	5476	2867	6426	3406	7448
37	1850	1342	4503	1867	5028	2393	5628	2947	6605	3500	7655
38	1900	1378	4624	1918	5164	2458	5781	3026	6783	3595	7862
39	1950	1414	4746	1968	5300	2523	5933	3106	6962	3689	8069
40	2000	1450	4868	2019	5436	2587	6085	3186	7140	3784	8276
41	2050	1487	4989	2069	5571	2652	6237	3265	7319	3879	8483
42	2100	1523	5111	2120	5707	2717	6389	3345	7497	3973	8690
43	2150	1559	5233	2170	5843	2781	6541	3425	7676	4068	8897
44	2200	1595	5354	2221	5979	2846	6693	3504	7854	4162	9104
45	2250	1632	5476	2271	6115	2911	6845	3584	8033	4257	9311
46	2300	1668	5598	2322	6251	2975	6998	3663	8211	4352	9517
47	2350	1704	5719	2372	6387	3040	7150	3743	8390	4446	9724
48	2400	1740	5841	2423	6523	3105	7302	3823	8568	4541	9931
49	2450	1777	5963	2473	6659	3169	7454	3902	8747	4635	10138
50	2500	1813	6085	2524	6795	3234	7606	3982	8925	4730	10345

Product Class
D12000

Item Group
OOD90A

ETIM Class
ECO03539

dane techniczne / ceny netto

Ceny nie zawierają zamocowań. **Niebieskie ceny:** dostawa możliwa w jednym bloku.

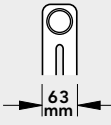
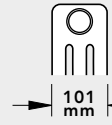
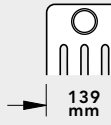
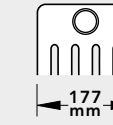
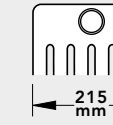
wysokość [mm]		2-kolumnowy		3-kolumnowy		4-kolumnowy		5-kolumnowy		6-kolumnowy	
500											
rozstaw króćców 435 mm											
typ		2050		3050		4050		5050		6050	
wykładnik n		1,2354		1,2499		1,2644		1,2702		1,2759	
poj. wody/człon w l		0,57		0,83		1,09		1,34		1,60	
waga/człon w kg		0,83		1,23		1,64		2,04		2,46	
człony	długość [mm]	[W]		[W]		[W]		[W]		[W]	
		PLN	PLN	PLN	PLN	PLN	PLN	PLN	PLN	PLN	
4	200	159	495	222	568	284	625	349	730	415	852
5	250	199	619	277	710	354	781	437	913	519	1065
6	300	239	742	332	852	425	937	524	1096	623	1278
7	350	279	866	388	994	496	1093	611	1278	726	1491
8	400	319	990	443	1136	567	1250	699	1461	830	1704
9	450	359	1114	498	1278	638	1406	786	1643	934	1917
10	500	399	1237	554	1420	709	1562	873	1826	1038	2130
11	550	439	1361	609	1562	780	1718	961	2008	1141	2343
12	600	478	1485	665	1704	851	1875	1048	2191	1245	2556
13	650	518	1608	720	1846	921	2031	1135	2374	1349	2769
14	700	558	1732	775	1988	992	2187	1222	2556	1453	2982
15	750	598	1856	831	2130	1063	2343	1310	2739	1556	3195
16	800	638	1980	886	2272	1134	2499	1397	2921	1660	3408
17	850	678	2103	941	2414	1205	2656	1484	3104	1764	3621
18	900	718	2227	997	2556	1276	2812	1572	3287	1868	3834
19	950	758	2351	1052	2698	1347	2968	1659	3469	1971	4047
20	1000	797	2475	1108	2840	1418	3124	1746	3652	2075	4260
21	1050	837	2598	1163	2982	1488	3280	1834	3834	2179	4473
22	1100	877	2722	1218	3124	1559	3437	1921	4017	2283	4686
23	1150	917	2846	1274	3266	1630	3593	2008	4200	2386	4899
24	1200	957	2970	1329	3408	1701	3749	2096	4382	2490	5112
25	1250	997	3093	1385	3550	1772	3905	2183	4565	2594	5325
26	1300	1037	3217	1440	3692	1843	4061	2270	4747	2698	5537
27	1350	1076	3341	1495	3834	1914	4218	2358	4930	2802	5750
28	1400	1116	3464	1551	3976	1985	4374	2445	5113	2905	5963
29	1450	1156	3588	1606	4118	2056	4530	2532	5295	3009	6176
30	1500	1196	3712	1661	4260	2126	4686	2620	5478	3113	6389
31	1550	1236	3836	1717	4402	2197	4843	2707	5660	3217	6602
32	1600	1276	3959	1772	4544	2268	4999	2794	5843	3320	6815
33	1650	1316	4083	1828	4686	2339	5155	2882	6025	3424	7028
34	1700	1356	4207	1883	4828	2410	5311	2969	6208	3528	7241
35	1750	1395	4331	1938	4970	2481	5467	3056	6391	3632	7454
36	1800	1435	4454	1994	5112	2552	5624	3144	6573	3735	7667
37	1850	1475	4578	2049	5254	2623	5780	3231	6756	3839	7880
38	1900	1515	4702	2104	5396	2693	5936	3318	6938	3943	8093
39	1950	1555	4825	2160	5538	2764	6092	3405	7121	4047	8306
40	2000	1595	4949	2215	5680	2835	6248	3493	7304	4150	8519
41	2050	1635	5073	2271	5822	2906	6405	3580	7486	4254	8732
42	2100	1675	5197	2326	5964	2977	6561	3667	7669	4358	8945
43	2150	1714	5320	2381	6106	3048	6717	3755	7851	4462	9158
44	2200	1754	5444	2437	6248	3119	6873	3842	8034	4565	9371
45	2250	1794	5568	2492	6390	3190	7029	3929	8217	4669	9584
46	2300	1834	5692	2547	6532	3260	7186	4017	8399	4773	9797
47	2350	1874	5815	2603	6674	3331	7342	4104	8582	4877	10010
48	2400	1914	5939	2658	6816	3402	7498	4191	8764	4980	10223
49	2450	1954	6063	2714	6958	3473	7654	4279	8947	5084	10436
50	2500	1994	6187	2769	7101	3544	7811	4366	9130	5188	10649

Standard

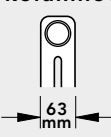
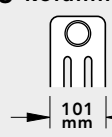
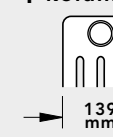
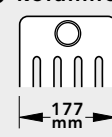
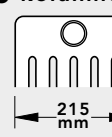
dane techniczne / ceny netto											
Ceny nie zawierają zamocowań. Niebieskie ceny : dostawa możliwa w jednym bloku.											
↑↓ wysokość [mm] 550	2-kolumnowy		3-kolumnowy		4-kolumnowy		5-kolumnowy		6-kolumnowy		
	 63 mm		 101 mm		 139 mm		 177 mm		 215 mm		
rozstaw króćców 485 mm	2055		3055		4055		5055		6055		
typ	2055		3055		4055		5055		6055		
wykładnik n	1,2384		1,2552		1,2720		1,2767		1,2813		
poj. wody/człon w l	0,62		0,89		1,17		1,45		1,73		
waga/człon w kg	0,91		1,34		1,79		2,23		2,68		
człony ←→	dtu- gość [mm]	[W] PLN		[W] PLN		[W] PLN		[W] PLN		[W] PLN	
		[W]	PLN	[W]	PLN	[W]	PLN	[W]	PLN	[W]	PLN
4	200	174	511	241	576	308	641	380	755	451	893
5	250	217	639	301	720	385	801	475	943	564	1116
6	300	261	767	362	864	462	962	570	1132	677	1339
7	350	304	895	422	1008	539	1122	665	1321	790	1562
8	400	348	1022	482	1152	616	1282	759	1509	903	1785
9	450	391	1150	542	1296	693	1442	854	1698	1015	2008
10	500	435	1278	603	1440	770	1603	949	1887	1128	2231
11	550	478	1406	663	1584	847	1763	1044	2075	1241	2454
12	600	522	1533	723	1728	924	1923	1139	2264	1354	2678
13	650	565	1661	783	1872	1001	2083	1234	2452	1467	2901
14	700	608	1789	844	2016	1078	2244	1329	2641	1580	3124
15	750	652	1917	904	2160	1155	2404	1424	2830	1692	3347
16	800	695	2045	964	2304	1232	2564	1519	3018	1805	3570
17	850	739	2172	1024	2448	1310	2724	1614	3207	1918	3793
18	900	782	2300	1085	2592	1387	2885	1709	3396	2031	4016
19	950	826	2428	1145	2736	1464	3045	1804	3584	2144	4239
20	1000	869	2556	1205	2880	1541	3205	1899	3773	2257	4463
21	1050	913	2684	1265	3024	1618	3365	1994	3962	2369	4686
22	1100	956	2811	1326	3168	1695	3526	2088	4150	2482	4909
23	1150	1000	2939	1386	3312	1772	3686	2183	4339	2595	5132
24	1200	1043	3067	1446	3456	1849	3846	2278	4528	2708	5355
25	1250	1087	3195	1506	3600	1926	4007	2373	4716	2821	5578
26	1300	1130	3323	1567	3744	2003	4167	2468	4905	2934	5801
27	1350	1173	3450	1627	3888	2080	4327	2563	5094	3046	6025
28	1400	1217	3578	1687	4032	2157	4487	2658	5282	3159	6248
29	1450	1260	3706	1747	4176	2234	4648	2753	5471	3272	6471
30	1500	1304	3834	1808	4320	2311	4808	2848	5660	3385	6694
31	1550	1347	3961	1868	4464	2388	4968	2943	5848	3498	6917
32	1600	1391	4089	1928	4608	2465	5128	3038	6037	3611	7140
33	1650	1434	4217	1988	4752	2542	5289	3133	6225	3723	7363
34	1700	1478	4345	2049	4896	2619	5449	3228	6414	3836	7586
35	1750	1521	4473	2109	5040	2696	5609	3323	6603	3949	7810
36	1800	1565	4600	2169	5184	2773	5769	3417	6791	4062	8033
37	1850	1608	4728	2229	5328	2850	5930	3512	6980	4175	8256
38	1900	1651	4856	2290	5472	2927	6090	3607	7169	4288	8479
39	1950	1695	4984	2350	5616	3004	6250	3702	7357	4400	8702
40	2000	1738	5112	2410	5760	3081	6410	3797	7546	4513	8925
41	2050	1782	5239	2470	5904	3158	6571	3892	7735	4626	9148
42	2100	1825	5367	2531	6048	3235	6731	3987	7923	4739	9371
43	2150	1869	5495	2591	6192	3312	6891	4082	8112	4852	9595
44	2200	1912	5623	2651	6336	3389	7051	4177	8301	4965	9818
45	2250	1956	5751	2711	6480	3466	7212	4272	8489	5077	10041
46	2300	1999	5878	2772	6624	3543	7372	4367	8678	5190	10264
47	2350	2043	6006	2832	6768	3620	7532	4462	8867	5303	10487
48	2400	2086	6134	2892	6912	3697	7692	4557	9055	5416	10710
49	2450	2130	6262	2952	7056	3774	7853	4652	9244	5529	10933
50	2500	2173	6390	3013	7201	3852	8013	4747	9433	5642	11157

Product Class D12000 Item Group OOD90A ETIM Class ECO03539

dane techniczne / ceny netto

Ceny nie zawierają zamocowań. **Niebieskie ceny:** dostawa możliwa w jednym bloku.

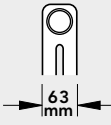
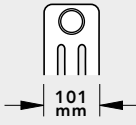
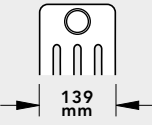
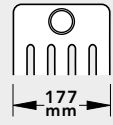
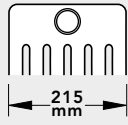
wysokość [mm]		2-kolumnowy		3-kolumnowy		4-kolumnowy		5-kolumnowy		6-kolumnowy	
565											
rozstaw króćców 500 mm											
typ		2057		3057		4057		5057		6057	
wykładnik n		1,2393		1,2568		1,2742		1,2786		1,2829	
poj. wody/człon w l		0,63		0,91		1,20		1,48		1,76	
waga/człon w kg		0,93		1,38		1,84		2,29		2,75	
człony	długość [mm]	[W]		[W]		[W]		[W]		[W]	
			PLN		PLN		PLN		PLN		PLN
4	200	178	511	247	584	315	665	389	779	462	925
5	250	223	639	309	730	394	832	486	974	578	1156
6	300	267	767	370	876	473	998	583	1168	693	1387
7	350	312	895	432	1022	552	1164	680	1363	809	1619
8	400	356	1022	494	1168	631	1330	778	1558	924	1850
9	450	401	1150	555	1314	710	1497	875	1752	1040	2081
10	500	445	1278	617	1461	789	1663	972	1947	1155	2312
11	550	490	1406	679	1607	867	1829	1069	2142	1271	2544
12	600	534	1533	740	1753	946	1996	1166	2337	1386	2775
13	650	579	1661	802	1899	1025	2162	1264	2531	1502	3006
14	700	623	1789	864	2045	1104	2328	1361	2726	1618	3237
15	750	668	1917	926	2191	1183	2495	1458	2921	1733	3469
16	800	712	2045	987	2337	1262	2661	1555	3116	1849	3700
17	850	757	2172	1049	2483	1341	2827	1652	3310	1964	3931
18	900	802	2300	1111	2629	1419	2993	1750	3505	2080	4162
19	950	846	2428	1172	2775	1498	3160	1847	3700	2195	4394
20	1000	891	2556	1234	2921	1577	3326	1944	3894	2311	4625
21	1050	935	2684	1296	3067	1656	3492	2041	4089	2426	4856
22	1100	980	2811	1357	3213	1735	3659	2138	4284	2542	5087
23	1150	1024	2939	1419	3359	1814	3825	2236	4479	2657	5319
24	1200	1069	3067	1481	3505	1893	3991	2333	4673	2773	5550
25	1250	1113	3195	1543	3651	1972	4158	2430	4868	2889	5781
26	1300	1158	3323	1604	3797	2050	4324	2527	5063	3004	6012
27	1350	1202	3450	1666	3943	2129	4490	2624	5257	3120	6243
28	1400	1247	3578	1728	4089	2208	4656	2722	5452	3235	6475
29	1450	1291	3706	1789	4235	2287	4823	2819	5647	3351	6706
30	1500	1336	3834	1851	4382	2366	4989	2916	5842	3466	6937
31	1550	1380	3961	1913	4528	2445	5155	3013	6036	3582	7168
32	1600	1425	4089	1974	4674	2524	5322	3110	6231	3697	7400
33	1650	1469	4217	2036	4820	2602	5488	3208	6426	3813	7631
34	1700	1514	4345	2098	4966	2681	5654	3305	6620	3928	7862
35	1750	1559	4473	2160	5112	2760	5821	3402	6815	4044	8093
36	1800	1603	4600	2221	5258	2839	5987	3499	7010	4159	8325
37	1850	1648	4728	2283	5404	2918	6153	3596	7205	4275	8556
38	1900	1692	4856	2345	5550	2997	6319	3694	7399	4391	8787
39	1950	1737	4984	2406	5696	3076	6486	3791	7594	4506	9018
40	2000	1781	5112	2468	5842	3154	6652	3888	7789	4622	9250
41	2050	1826	5239	2530	5988	3233	6818	3985	7984	4737	9481
42	2100	1870	5367	2591	6134	3312	6985	4082	8178	4853	9712
43	2150	1915	5495	2653	6280	3391	7151	4180	8373	4968	9943
44	2200	1959	5623	2715	6426	3470	7317	4277	8568	5084	10175
45	2250	2004	5751	2777	6572	3549	7484	4374	8762	5199	10406
46	2300	2048	5878	2838	6718	3628	7650	4471	8957	5315	10637
47	2350	2093	6006	2900	6864	3706	7816	4568	9152	5430	10868
48	2400	2137	6134	2962	7010	3785	7982	4666	9347	5546	11100
49	2450	2182	6262	3023	7156	3864	8149	4763	9541	5661	11331
50	2500	2227	6390	3085	7303	3943	8315	4860	9736	5777	11562

Standard

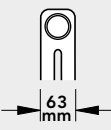
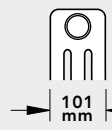
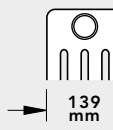
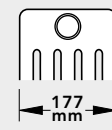
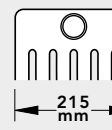
dane techniczne / ceny netto											
Ceny nie zawierają zamocowań. Niebieskie ceny dostawa możliwa w jednym bloku.											
wysokość [mm] 600	2-kolumnowy		3-kolumnowy		4-kolumnowy		5-kolumnowy		6-kolumnowy		
	 63 mm		 101 mm		 139 mm		 177 mm		 215 mm		
rozstaw króćców 535 mm	typ	2060	3060	4060	5060	6060					
wykładnik n		1,2415	1,2604	1,2793	1,2829	1,2865					
poj. wody/człon w l		0,66	0,96	1,26	1,55	1,85					
waga/człon w kg		0,98	1,46	1,94	2,42	2,91					
człony	dtu- gość [mm]	[W]		[W]		[W]		[W]		[W]	
		PLN	PLN	PLN	PLN	PLN	PLN	PLN	PLN		
4	200	188	519	260	592	332	673	410	787	487	925
5	250	235	649	325	740	416	842	512	984	609	1156
6	300	282	779	390	888	499	1010	615	1181	731	1387
7	350	329	909	455	1037	582	1178	717	1377	853	1619
8	400	376	1039	521	1185	665	1347	820	1574	975	1850
9	450	423	1168	586	1333	748	1515	922	1771	1096	2081
10	500	470	1298	651	1481	831	1684	1025	1968	1218	2312
11	550	517	1428	716	1629	914	1852	1127	2164	1340	2544
12	600	564	1558	781	1777	997	2020	1230	2361	1462	2775
13	650	611	1688	846	1925	1081	2189	1332	2558	1584	3006
14	700	658	1817	911	2073	1164	2357	1435	2755	1706	3237
15	750	705	1947	976	2221	1247	2525	1537	2951	1827	3469
16	800	752	2077	1041	2369	1330	2694	1640	3148	1949	3700
17	850	799	2207	1106	2517	1413	2862	1742	3345	2071	3931
18	900	846	2337	1171	2665	1496	3030	1845	3542	2193	4162
19	950	893	2467	1236	2814	1579	3199	1947	3738	2315	4394
20	1000	940	2596	1301	2962	1662	3367	2050	3935	2437	4625
21	1050	987	2726	1366	3110	1746	3535	2152	4132	2558	4856
22	1100	1034	2856	1432	3258	1829	3704	2255	4329	2680	5087
23	1150	1081	2986	1497	3406	1912	3872	2357	4525	2802	5319
24	1200	1128	3116	1562	3554	1995	4040	2460	4722	2924	5550
25	1250	1176	3246	1627	3702	2078	4209	2562	4919	3046	5781
26	1300	1223	3375	1692	3850	2161	4377	2664	5116	3168	6012
27	1350	1270	3505	1757	3998	2244	4545	2767	5313	3289	6243
28	1400	1317	3635	1822	4146	2327	4714	2869	5509	3411	6475
29	1450	1364	3765	1887	4294	2410	4882	2972	5706	3533	6706
30	1500	1411	3895	1952	4442	2494	5051	3074	5903	3655	6937
31	1550	1458	4024	2017	4590	2577	5219	3177	6100	3777	7168
32	1600	1505	4154	2082	4739	2660	5387	3279	6296	3899	7400
33	1650	1552	4284	2147	4887	2743	5556	3382	6493	4020	7631
34	1700	1599	4414	2212	5035	2826	5724	3484	6690	4142	7862
35	1750	1646	4544	2277	5183	2909	5892	3587	6887	4264	8093
36	1800	1693	4674	2343	5331	2992	6061	3689	7083	4386	8325
37	1850	1740	4803	2408	5479	3075	6229	3792	7280	4508	8556
38	1900	1787	4933	2473	5627	3159	6397	3894	7477	4630	8787
39	1950	1834	5063	2538	5775	3242	6566	3997	7674	4751	9018
40	2000	1881	5193	2603	5923	3325	6734	4099	7870	4873	9250
41	2050	1928	5323	2668	6071	3408	6902	4202	8067	4995	9481
42	2100	1975	5452	2733	6219	3491	7071	4304	8264	5117	9712
43	2150	2022	5582	2798	6367	3574	7239	4407	8461	5239	9943
44	2200	2069	5712	2863	6516	3657	7407	4509	8657	5361	10175
45	2250	2116	5842	2928	6664	3740	7576	4612	8854	5482	10406
46	2300	2163	5972	2993	6812	3824	7744	4714	9051	5604	10637
47	2350	2210	6102	3058	6960	3907	7912	4817	9248	5726	10868
48	2400	2257	6231	3123	7108	3990	8081	4919	9444	5848	11100
49	2450	2304	6361	3188	7256	4073	8249	5022	9641	5970	11331
50	2500	2351	6491	3254	7404	4156	8418	5124	9838	6092	11562

Product Class D12000 Item Group OOD90A ETIM Class ECO03539

dane techniczne / ceny netto

Ceny nie zawierają zamocowań. **Niebieskie ceny:** dostawa możliwa w jednym bloku.

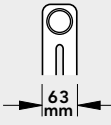
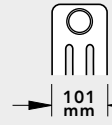
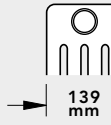
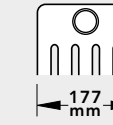
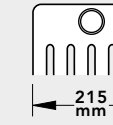

wysokość [mm]		2-kolumnowy		3-kolumnowy		4-kolumnowy		5-kolumnowy		6-kolumnowy	
665											
rozstaw króćców 600 mm											
typ		2067		3067		4067		5067		6067	
wyktadnik n		1,2457		1,2669		1,2881		1,2905		1,2929	
poj. wody/człon w l		0,72		1,04		1,37		1,69		2,01	
waga/człon w kg		1,08		1,60		2,14		2,66		3,20	
człony	długość [mm]	[W]		[W]		[W]		[W]		[W]	
			PLN		PLN		PLN		PLN		PLN
4	200	207	536	285	617	364	755	449	909	534	1030
5	250	258	669	357	771	455	943	561	1136	667	1288
6	300	310	803	428	925	546	1132	673	1363	801	1546
7	350	361	937	499	1079	637	1321	785	1590	934	1803
8	400	413	1071	570	1233	728	1509	898	1818	1067	2061
9	450	465	1205	642	1387	819	1698	1010	2045	1201	2318
10	500	516	1339	713	1541	910	1887	1122	2272	1334	2576
11	550	568	1473	784	1695	1001	2075	1234	2499	1468	2834
12	600	620	1607	856	1850	1092	2264	1346	2726	1601	3091
13	650	671	1740	927	2004	1183	2452	1459	2953	1734	3349
14	700	723	1874	998	2158	1274	2641	1571	3181	1868	3607
15	750	775	2008	1070	2312	1365	2830	1683	3408	2001	3864
16	800	826	2142	1141	2466	1456	3018	1795	3635	2135	4122
17	850	878	2276	1212	2620	1546	3207	1907	3862	2268	4379
18	900	930	2410	1284	2774	1637	3396	2020	4089	2402	4637
19	950	981	2544	1355	2928	1728	3584	2132	4317	2535	4895
20	1000	1033	2678	1426	3083	1819	3773	2244	4544	2668	5152
21	1050	1084	2811	1498	3237	1910	3962	2356	4771	2802	5410
22	1100	1136	2945	1569	3391	2001	4150	2468	4998	2935	5667
23	1150	1188	3079	1640	3545	2092	4339	2581	5225	3069	5925
24	1200	1239	3213	1711	3699	2183	4528	2693	5453	3202	6183
25	1250	1291	3347	1783	3853	2274	4716	2805	5680	3336	6440
26	1300	1343	3481	1854	4007	2365	4905	2917	5907	3469	6698
27	1350	1394	3615	1925	4162	2456	5094	3029	6134	3602	6955
28	1400	1446	3749	1997	4316	2547	5282	3142	6361	3736	7213
29	1450	1498	3883	2068	4470	2638	5471	3254	6589	3869	7471
30	1500	1549	4016	2139	4624	2729	5660	3366	6816	4003	7728
31	1550	1601	4150	2211	4778	2820	5848	3478	7043	4136	7986
32	1600	1652	4284	2282	4932	2911	6037	3590	7270	4269	8244
33	1650	1704	4418	2353	5086	3002	6225	3703	7497	4403	8501
34	1700	1756	4552	2425	5240	3093	6414	3815	7724	4536	8759
35	1750	1807	4686	2496	5395	3184	6603	3927	7952	4670	9016
36	1800	1859	4820	2567	5549	3275	6791	4039	8179	4803	9274
37	1850	1911	4954	2638	5703	3366	6980	4151	8406	4937	9532
38	1900	1962	5087	2710	5857	3457	7169	4264	8633	5070	9789
39	1950	2014	5221	2781	6011	3548	7357	4376	8860	5203	10047
40	2000	2066	5355	2852	6165	3639	7546	4488	9088	5337	10304
41	2050	2117	5489	2924	6319	3730	7735	4600	9315	5470	10562
42	2100	2169	5623	2995	6473	3821	7923	4712	9542	5604	10820
43	2150	2221	5757	3066	6628	3912	8112	4825	9769	5737	11077
44	2200	2272	5891	3138	6782	4003	8301	4937	9996	5870	11335
45	2250	2324	6025	3209	6936	4094	8489	5049	10224	6004	11592
46	2300	2375	6158	3280	7090	4185	8678	5161	10451	6137	11850
47	2350	2427	6292	3352	7244	4276	8867	5273	10678	6271	12108
48	2400	2479	6426	3423	7398	4367	9055	5386	10905	6404	12365
49	2450	2530	6560	3494	7552	4458	9244	5498	11132	6538	12623
50	2500	2582	6694	3566	7707	4549	9433	5610	11360	6671	12881

Moc cieplna grzejników [W] wg normy EN 442 dla parametrów 75/65/20 °C. PKWU 25.21.11.0; CN 2020 7322 1900. Ceny netto w zł bez podatku VAT.

20 LASERLINE STANDARD

Ceny i wydajność cieplna

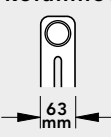
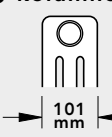
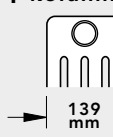
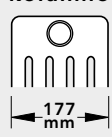
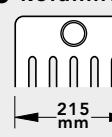
Product Class D12000 Item Group OOD90A ETIM Class EC003539



dane techniczne / ceny netto											
Ceny nie zawierają zamocowań. Niebieskie ceny dostawa możliwa w jednym bloku.											
wysokość [mm] 750	2-kolumnowy		3-kolumnowy		4-kolumnowy		5-kolumnowy		6-kolumnowy		
	 63 mm		 101 mm		 139 mm		 177 mm		 215 mm		
rozstaw króćców 685 mm	2075		3075		4075		5075		6075		
typ	2075		3075		4075		5075		6075		
wykładnik n	1,2513		1,2750		1,2986		1,2997		1,3008		
poj. wody/człon w l	0,80		1,15		1,51		1,86		2,22		
waga/człon w kg	1,21		1,79		2,39		2,97		3,58		
człony	 dtu- gość [mm]	[W]	PLN	[W]	PLN	[W]	PLN	[W]	PLN	[W]	PLN
4	200	231	552	318	633	405	771	499	909	594	1055
5	250	288	690	397	791	506	964	624	1136	742	1319
6	300	346	828	476	949	607	1156	749	1363	891	1582
7	350	404	966	556	1107	708	1349	874	1590	1039	1846
8	400	461	1104	635	1266	809	1542	998	1818	1188	2110
9	450	519	1242	715	1424	910	1734	1123	2045	1336	2373
10	500	577	1380	794	1582	1012	1927	1248	2272	1485	2637
11	550	634	1517	873	1740	1113	2120	1373	2499	1633	2901
12	600	692	1655	953	1899	1214	2312	1498	2726	1781	3164
13	650	749	1793	1032	2057	1315	2505	1622	2953	1930	3428
14	700	807	1931	1112	2215	1416	2698	1747	3181	2078	3692
15	750	865	2069	1191	2373	1517	2891	1872	3408	2227	3956
16	800	922	2207	1270	2531	1618	3083	1997	3635	2375	4219
17	850	980	2345	1350	2690	1720	3276	2122	3862	2524	4483
18	900	1038	2483	1429	2848	1821	3469	2246	4089	2672	4747
19	950	1095	2621	1509	3006	1922	3661	2371	4317	2821	5010
20	1000	1153	2759	1588	3164	2023	3854	2496	4544	2969	5274
21	1050	1211	2897	1667	3322	2124	4047	2621	4771	3117	5538
22	1100	1268	3035	1747	3481	2225	4239	2746	4998	3266	5801
23	1150	1326	3173	1826	3639	2326	4432	2870	5225	3414	6065
24	1200	1384	3311	1906	3797	2428	4625	2995	5453	3563	6329
25	1250	1441	3449	1985	3955	2529	4818	3120	5680	3711	6593
26	1300	1499	3587	2064	4113	2630	5010	3245	5907	3860	6856
27	1350	1557	3725	2144	4272	2731	5203	3370	6134	4008	7120
28	1400	1614	3863	2223	4430	2832	5396	3494	6361	4157	7384
29	1450	1672	4001	2303	4588	2933	5588	3619	6589	4305	7647
30	1500	1730	4139	2382	4746	3035	5781	3744	6816	4454	7911
31	1550	1787	4276	2461	4905	3136	5974	3869	7043	4602	8175
32	1600	1845	4414	2541	5063	3237	6166	3994	7270	4750	8438
33	1650	1902	4552	2620	5221	3338	6359	4118	7497	4899	8702
34	1700	1960	4690	2700	5379	3439	6552	4243	7724	5047	8966
35	1750	2018	4828	2779	5537	3540	6745	4368	7952	5196	9230
36	1800	2075	4966	2858	5696	3641	6937	4493	8179	5344	9493
37	1850	2133	5104	2938	5854	3743	7130	4618	8406	5493	9757
38	1900	2191	5242	3017	6012	3844	7323	4742	8633	5641	10021
39	1950	2248	5380	3097	6170	3945	7515	4867	8860	5790	10284
40	2000	2306	5518	3176	6328	4046	7708	4992	9088	5938	10548
41	2050	2364	5656	3255	6487	4147	7901	5117	9315	6086	10812
42	2100	2421	5794	3335	6645	4248	8093	5242	9542	6235	11075
43	2150	2479	5932	3414	6803	4349	8286	5366	9769	6383	11339
44	2200	2537	6070	3494	6961	4451	8479	5491	9996	6532	11603
45	2250	2594	6208	3573	7119	4552	8672	5616	10224	6680	11867
46	2300	2652	6346	3652	7278	4653	8864	5741	10451	6829	12130
47	2350	2710	6484	3732	7436	4754	9057	5866	10678	6977	12394
48	2400	2767	6622	3811	7594	4855	9250	5990	10905	7126	12658
49	2450	2825	6760	3891	7752	4956	9442	6115	11132	7274	12921
50	2500	2883	6898	3970	7911	5058	9635	6240	11360	7423	13185

Moc cieplna grzejników [W] wg normy EN 442 dla parametrów 75/65/20 °C. PKWU 25.21.11.0; CN 2020 7322 1900. Ceny netto w zł bez podatku VAT.

Product Class D12000 Item Group OOD90A ETIM Class ECO03539

dane techniczne / ceny netto

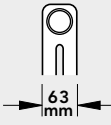
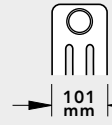
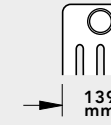
Ceny nie zawierają zamocowań. **Niebieskie ceny:** dostawa możliwa w jednym bloku.

wysokość [mm]	2-kolumnowy		3-kolumnowy		4-kolumnowy		5-kolumnowy		6-kolumnowy		
											
rozstaw króćców 835 mm	63 mm		101 mm		139 mm		177 mm		215 mm		
typ	2090		3090		4090		5090		6090		
wyktadnik n	1,2615		1,2881		1,3147		1,3139		1,3131		
poj. wody/człon w l	0,93		1,34		1,76		2,17		2,59		
waga/człon w kg	1,44		2,13		2,84		3,53		4,24		
człony	dku-gość [mm]	[W]	PLN	[W]	PLN	[W]	PLN	[W]	PLN	[W]	PLN
4	200	273	584	374	682	476	876	587	1022	699	1193
5	250	341	730	468	852	595	1095	734	1278	873	1491
6	300	409	876	561	1022	714	1314	881	1534	1048	1789
7	350	478	1022	655	1193	832	1533	1028	1789	1223	2087
8	400	546	1168	749	1363	951	1752	1174	2045	1397	2385
9	450	614	1314	842	1533	1070	1972	1321	2300	1572	2684
10	500	682	1461	936	1704	1189	2191	1468	2556	1747	2982
11	550	750	1607	1029	1874	1308	2410	1615	2811	1921	3280
12	600	819	1753	1123	2045	1427	2629	1761	3067	2096	3578
13	650	887	1899	1216	2215	1546	2848	1908	3323	2270	3876
14	700	955	2045	1310	2385	1665	3067	2055	3578	2445	4175
15	750	1023	2191	1404	2556	1784	3286	2202	3834	2620	4473
16	800	1092	2337	1497	2726	1903	3505	2349	4089	2794	4771
17	850	1160	2483	1591	2896	2022	3724	2495	4345	2969	5069
18	900	1228	2629	1684	3067	2141	3943	2642	4601	3144	5367
19	950	1296	2775	1778	3237	2259	4162	2789	4856	3318	5665
20	1000	1364	2921	1871	3408	2378	4381	2936	5112	3493	5964
21	1050	1433	3067	1965	3578	2497	4600	3083	5367	3668	6262
22	1100	1501	3213	2059	3748	2616	4819	3229	5623	3842	6560
23	1150	1569	3359	2152	3919	2735	5038	3376	5879	4017	6858
24	1200	1637	3505	2246	4089	2854	5257	3523	6134	4192	7156
25	1250	1706	3651	2339	4260	2973	5477	3670	6390	4366	7455
26	1300	1774	3797	2433	4430	3092	5696	3817	6645	4541	7753
27	1350	1842	3943	2526	4600	3211	5915	3963	6901	4716	8051
28	1400	1910	4089	2620	4771	3330	6134	4110	7157	4890	8349
29	1450	1978	4235	2714	4941	3449	6353	4257	7412	5065	8647
30	1500	2047	4382	2807	5111	3568	6572	4404	7668	5240	8945
31	1550	2115	4528	2901	5282	3687	6791	4550	7923	5414	9244
32	1600	2183	4674	2994	5452	3805	7010	4697	8179	5589	9542
33	1650	2251	4820	3088	5623	3924	7229	4844	8434	5763	9840
34	1700	2319	4966	3181	5793	4043	7448	4991	8690	5938	10138
35	1750	2388	5112	3275	5963	4162	7667	5138	8946	6113	10436
36	1800	2456	5258	3369	6134	4281	7886	5284	9201	6287	10734
37	1850	2524	5404	3462	6304	4400	8105	5431	9457	6462	11033
38	1900	2592	5550	3556	6474	4519	8324	5578	9712	6637	11331
39	1950	2661	5696	3649	6645	4638	8543	5725	9968	6811	11629
40	2000	2729	5842	3743	6815	4757	8762	5872	10224	6986	11927
41	2050	2797	5988	3836	6986	4876	8981	6018	10479	7161	12225
42	2100	2865	6134	3930	7156	4995	9201	6165	10735	7335	12524
43	2150	2933	6280	4024	7326	5114	9420	6312	10990	7510	12822
44	2200	3002	6426	4117	7497	5232	9639	6459	11246	7685	13120
45	2250	3070	6572	4211	7667	5351	9858	6606	11502	7859	13418
46	2300	3138	6718	4304	7837	5470	10077	6752	11757	8034	13716
47	2350	3206	6864	4398	8008	5589	10296	6899	12013	8209	14014
48	2400	3275	7010	4491	8178	5708	10515	7046	12268	8383	14313
49	2450	3343	7156	4585	8349	5827	10734	7193	12524	8558	14611
50	2500	3411	7303	4679	8519	5946	10953	7340	12780	8733	14909

Standard

22 LASERLINE STANDARD

Ceny i wydajność cieplna

Product Class D12000 Item Group OOD90A ETIM Class EC003539

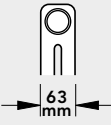
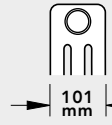
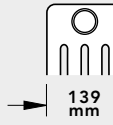
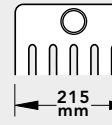

dane techniczne / ceny netto												
Ceny nie zawierają zamocowań. Niebieskie ceny dostawa możliwa w jednym bloku.												
↑↓ wysokość [mm] 965	2-kolumnowy			3-kolumnowy			4-kolumnowy			6-kolumnowy		
	 63 mm			 101 mm			 139 mm			 215 mm		
rozstaw króćców 900 mm	2097			3097			4097			6097		
typ	2097			3097			4097			6097		
wykładnik n	1,2660			1,2934			1,3207			1,3179		
poj. wody/człon w l	0,99			1,42			1,87			2,75		
waga/człon w kg	1,54			2,28			3,04			4,53		
człony ←	dtu- gość [mm] →	[W]	PLN	[W]	PLN	[W]	PLN	[W]	PLN	[W]	PLN	
4	200	291	592	399	714	506	941			744	1274	
5	250	364	740	498	893	633	1176			930	1592	
6	300	437	888	598	1071	759	1412			1115	1911	
7	350	510	1037	698	1250	886	1647			1301	2229	
8	400	582	1185	798	1428	1013	1882			1487	2548	
9	450	655	1333	897	1607	1139	2118			1673	2866	
10	500	728	1481	997	1785	1266	2353			1859	3185	
11	550	801	1629	1097	1964	1392	2588			2045	3503	
12	600	874	1777	1196	2142	1519	2823			2231	3822	
13	650	946	1925	1296	2321	1645	3059			2417	4140	
14	700	1019	2073	1396	2499	1772	3294			2603	4459	
15	750	1092	2221	1495	2678	1899	3529			2789	4777	
16	800	1165	2369	1595	2856	2025	3764			2975	5096	
17	850	1238	2517	1695	3035	2152	4000			3160	5414	
18	900	1310	2665	1794	3213	2278	4235			3346	5733	
19	950	1383	2814	1894	3392	2405	4470			3532	6051	
20	1000	1456	2962	1994	3570	2531	4706			3718	6370	
21	1050	1529	3110	2093	3749	2658	4941			3904	6688	
22	1100	1602	3258	2193	3927	2785	5176			4090	7007	
23	1150	1674	3406	2293	4106	2911	5411			4276	7325	
24	1200	1747	3554	2393	4284	3038	5647			4462	7644	
25	1250	1820	3702	2492	4463	3164	5882			4648	7962	
26	1300	1893	3850	2592	4641	3291	6117			4834	8281	
27	1350	1966	3998	2692	4820	3417	6353			5020	8599	
28	1400	2038	4146	2791	4998	3544	6588			5205	8918	
29	1450	2111	4294	2891	5177	3671	6823			5391	9236	
30	1500	2184	4442	2991	5355	3797	7058			5577	9555	
31	1550	2257	4590	3090	5534	3924	7294			5763	9873	
32	1600	2330	4739	3190	5712	4050	7529			5949	10192	
33	1650	2402	4887	3290	5891	4177	7764			6135	10510	
34	1700	2475	5035	3389	6069	4303	8000			6321	10829	
35	1750	2548	5183	3489	6248	4430	8235			6507	11147	
36	1800	2621	5331	3589	6426	4557	8470			6693	11466	
37	1850	2694	5479	3689	6605	4683	8705			6879	11784	
38	1900	2766	5627	3788	6783	4810	8941			7065	12103	
39	1950	2839	5775	3888	6962	4936	9176			7250	12421	
40	2000	2912	5923	3988	7140	5063	9411			7436	12740	
41	2050	2985	6071	4087	7319	5189	9646			7622	13058	
42	2100	3058	6219	4187	7497	5316	9882			7808	13377	
43	2150	3130	6367	4287	7676	5443	10117			7994	13695	
44	2200	3203	6516	4386	7854	5569	10352			8180	14014	
45	2250	3276	6664	4486	8033	5696	10588			8366	14332	
46	2300	3349	6812	4586	8211	5822	10823			8552	14651	
47	2350	3422	6960	4685	8390	5949	11058			8738	14969	
48	2400	3494	7108	4785	8568	6075	11293			8924	15288	
49	2450	3567	7256	4885	8747	6202	11529			9110	15606	
50	2500	3640	7404	4985	8925	6329	11764			9296	15925	

Moc cieplna grzejników [W] wg normy EN 442 dla parametrów 75/65/20 °C. PKWiU 25.21.11.0; CN 2020 7322 1900. Ceny netto w zł bez podatku VAT.

Product Class D12000 Item Group OOD90A ETIM Class ECO03539

dane techniczne / ceny netto

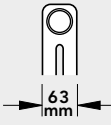
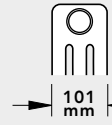
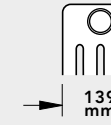
Ceny nie zawierają zamocowań. **Niebieskie ceny:** dostawa możliwa w jednym bloku.

wysokość [mm] 1000		2-kolumnowy		3-kolumnowy		4-kolumnowy		5-kolumnowy		6-kolumnowy	
rozstaw króćców 935 mm											
typ		2100		3100		4100		5100		6100	
wykładnik n		1,2684		1,2961		1,3237		1,3220		1,3203	
poj. wody/człon w l		1,02		1,47		1,93		2,38		2,84	
waga/człon w kg		1,59		2,36		3,14		3,91		4,69	
człony	dku- gość [mm]	[W]	PLN	[W]	PLN	[W]	PLN	[W]	PLN	[W]	PLN
4	200	301	600	412	714	523	941	645	1095	768	1282
5	250	376	750	515	893	653	1176	807	1369	960	1602
6	300	452	901	618	1071	784	1412	968	1643	1152	1923
7	350	527	1051	721	1250	915	1647	1129	1917	1344	2243
8	400	602	1201	824	1428	1045	1882	1290	2191	1536	2564
9	450	677	1351	927	1607	1176	2118	1452	2465	1728	2884
10	500	753	1501	1030	1785	1307	2353	1613	2738	1920	3205
11	550	828	1651	1133	1964	1437	2588	1774	3012	2111	3525
12	600	903	1801	1236	2142	1568	2823	1936	3286	2303	3846
13	650	978	1951	1339	2321	1699	3059	2097	3560	2495	4166
14	700	1054	2101	1442	2499	1829	3294	2258	3834	2687	4487
15	750	1129	2251	1545	2678	1960	3529	2420	4108	2879	4807
16	800	1204	2401	1648	2856	2091	3764	2581	4381	3071	5128
17	850	1279	2552	1750	3035	2221	4000	2742	4655	3263	5448
18	900	1355	2702	1853	3213	2352	4235	2904	4929	3455	5769
19	950	1430	2852	1956	3392	2483	4470	3065	5203	3647	6089
20	1000	1505	3002	2059	3570	2613	4706	3226	5477	3839	6410
21	1050	1580	3152	2162	3749	2744	4941	3388	5751	4031	6730
22	1100	1656	3302	2265	3927	2875	5176	3549	6024	4223	7051
23	1150	1731	3452	2368	4106	3005	5411	3710	6298	4415	7371
24	1200	1806	3602	2471	4284	3136	5647	3871	6572	4607	7692
25	1250	1882	3752	2574	4463	3267	5882	4033	6846	4799	8012
26	1300	1957	3902	2677	4641	3397	6117	4194	7120	4991	8332
27	1350	2032	4052	2780	4820	3528	6353	4355	7394	5183	8653
28	1400	2107	4203	2883	4998	3659	6588	4517	7668	5375	8973
29	1450	2183	4353	2986	5177	3789	6823	4678	7941	5567	9294
30	1500	2258	4503	3089	5355	3920	7058	4839	8215	5759	9614
31	1550	2333	4653	3192	5534	4051	7294	5001	8489	5950	9935
32	1600	2408	4803	3295	5712	4181	7529	5162	8763	6142	10255
33	1650	2484	4953	3398	5891	4312	7764	5323	9037	6334	10576
34	1700	2559	5103	3501	6069	4443	8000	5485	9311	6526	10896
35	1750	2634	5253	3604	6248	4573	8235	5646	9584	6718	11217
36	1800	2709	5403	3707	6426	4704	8470	5807	9858	6910	11537
37	1850	2785	5553	3810	6605	4835	8705	5968	10132	7102	11858
38	1900	2860	5703	3913	6783	4965	8941	6130	10406	7294	12178
39	1950	2935	5854	4016	6962	5096	9176	6291	10680	7486	12499
40	2000	3010	6004	4119	7140	5227	9411	6452	10954	7678	12819
41	2050	3086	6154	4222	7319	5357	9646	6614	11227	7870	13140
42	2100	3161	6304	4325	7497	5488	9882	6775	11501	8062	13460
43	2150	3236	6454	4428	7676	5619	10117	6936	11775	8254	13781
44	2200	3311	6604	4531	7854	5749	10352	7098	12049	8446	14101
45	2250	3387	6754	4634	8033	5880	10588	7259	12323	8638	14422
46	2300	3462	6904	4737	8211	6011	10823	7420	12597	8830	14742
47	2350	3537	7054	4840	8390	6141	11058	7582	12870	9022	15063
48	2400	3612	7204	4943	8568	6272	11293	7743	13144	9214	15383
49	2450	3688	7354	5046	8747	6403	11529	7904	13418	9406	15704
50	2500	3763	7505	5149	8925	6534	11764	8066	13692	9598	16024

Standard

24 LASERLINE STANDARD

Ceny i wydajność cieplna

Product Class D12000 Item Group OOD90A ETIM Class EC003539

dane techniczne / ceny netto

Ceny nie zawierają zamocowań. **Niebieskie ceny** dostawa możliwa w jednym bloku.

wysokość [mm]				3-kolumnowy		4-kolumnowy		5-kolumnowy		6-kolumnowy	
1065				101 mm		139 mm		177 mm		215 mm	
rozstaw króćców 1000 mm											
typ				3107		4107		5107		6107	
wykładnik n				1,3009		1,3288		1,3267		1,3245	
poj. wody/człon w l				1,55		2,04		2,52		3,00	
waga/człon w kg				2,46		3,24		4,15		4,98	
człony	dtu- gość [mm]	[W]	PLN	[W]	PLN	[W]	PLN	[W]	PLN	[W]	PLN
4	200			436	795	553	1047	683	1241	813	1460
5	250			545	994	691	1308	854	1552	1016	1826
6	300			654	1193	830	1570	1024	1862	1219	2191
7	350			763	1392	968	1832	1195	2173	1422	2556
8	400			873	1590	1106	2093	1366	2483	1625	2921
9	450			982	1789	1245	2355	1536	2793	1828	3286
10	500			1091	1988	1383	2617	1707	3104	2032	3651
11	550			1200	2187	1521	2878	1878	3414	2235	4016
12	600			1309	2385	1659	3140	2049	3724	2438	4381
13	650			1418	2584	1798	3401	2219	4035	2641	4746
14	700			1527	2783	1936	3663	2390	4345	2844	5112
15	750			1636	2982	2074	3925	2561	4655	3047	5477
16	800			1745	3181	2213	4186	2732	4966	3250	5842
17	850			1854	3379	2351	4448	2902	5276	3454	6207
18	900			1963	3578	2489	4710	3073	5586	3657	6572
19	950			2072	3777	2628	4971	3244	5897	3860	6937
20	1000			2181	3976	2766	5233	3414	6207	4063	7302
21	1050			2290	4175	2904	5495	3585	6518	4266	7667
22	1100			2400	4373	3042	5756	3756	6828	4469	8032
23	1150			2509	4572	3181	6018	3927	7138	4672	8398
24	1200			2618	4771	3319	6280	4097	7449	4876	8763
25	1250			2727	4970	3457	6541	4268	7759	5079	9128
26	1300			2836	5169	3596	6803	4439	8069	5282	9493
27	1350			2945	5367	3734	7065	4609	8380	5485	9858
28	1400			3054	5566	3872	7326	4780	8690	5688	10223
29	1450			3163	5765	4010	7588	4951	9000	5891	10588
30	1500			3272	5964	4149	7850	5122	9311	6095	10953
31	1550			3381	6162	4287	8111	5292	9621	6298	11318
32	1600			3490	6361	4425	8373	5463	9932	6501	11684
33	1650			3599	6560	4564	8634	5634	10242	6704	12049
34	1700			3708	6759	4702	8896	5804	10552	6907	12414
35	1750			3817	6958	4840	9158	5975	10863	7110	12779
36	1800			3927	7156	4978	9419	6146	11173	7313	13144
37	1850			4036	7355	5117	9681	6317	11483	7517	13509
38	1900			4145	7554	5255	9943	6487	11794	7720	13874
39	1950			4254	7753	5393	10204	6658	12104	7923	14239
40	2000			4363	7952	5532	10466	6829	12414	8126	14604
41	2050			4472	8150	5670	10728	7000	12725	8329	14970
42	2100			4581	8349	5808	10989	7170	13035	8532	15335
43	2150			4690	8548	5946	11251	7341	13345	8735	15700
44	2200			4799	8747	6085	11513	7512	13656	8939	16065
45	2250			4908	8946	6223	11774	7682	13966	9142	16430
46	2300			5017	9144	6361	12036	7853	14277	9345	16795
47	2350			5126	9343	6500	12298	8024	14587	9548	17160
48	2400			5235	9542	6638	12559	8195	14897	9751	17525
49	2450			5344	9741	6776	12821	8365	15208	9954	17890
50	2500			5454	9940	6915	13083	8536	15518	10158	18256

Moc cieplna grzejników [W] wg normy EN 442 dla parametrów 75/65/20 °C. PKWiU 25.21.11.0; CN 2020 7322 1900. Ceny netto w zł bez podatku VAT.

Product Class D12000 Item Group OOD90A ETIM Class ECO03539

dane techniczne / ceny netto

Ceny nie zawierają zamocowań. **Niebieskie ceny**: dostawa możliwa w jednym bloku.

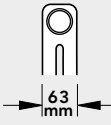
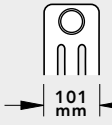
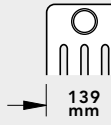
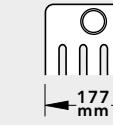
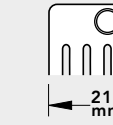





wysokość [mm] 1100	2-kolumnowy		3-kolumnowy		4-kolumnowy		5-kolumnowy		6-kolumnowy		
											
rozstaw króćców 1035 mm	63 mm		101 mm		139 mm		177 mm		215 mm		
typ	2110		3110		4110		5110		6110		
wyktadnik n	1,2754		1,3034		1,3314		1,3290		1,3266		
poj. wody/człon w l	1,11		1,60		2,10		2,59		3,10		
waga/człon w kg	1,75		2,59		3,44		4,28		5,14		
człony	długość [mm]	[W]		[W]		[W]		[W]		[W]	
		PLN	PLN	PLN	PLN	PLN	PLN	PLN	PLN		
4	200	329	641	449	819	570	1071	703	1282	837	1509
5	250	412	801	562	1024	712	1339	879	1602	1046	1886
6	300	494	962	674	1229	854	1607	1055	1923	1255	2264
7	350	576	1122	786	1434	997	1874	1230	2243	1464	2641
8	400	658	1282	899	1639	1139	2142	1406	2564	1673	3018
9	450	741	1442	1011	1844	1281	2410	1582	2884	1882	3396
10	500	823	1603	1123	2049	1424	2678	1758	3205	2092	3773
11	550	905	1763	1236	2254	1566	2945	1933	3525	2301	4150
12	600	988	1923	1348	2458	1709	3213	2109	3846	2510	4527
13	650	1070	2083	1460	2663	1851	3481	2285	4166	2719	4905
14	700	1152	2244	1573	2868	1993	3749	2461	4487	2928	5282
15	750	1235	2404	1685	3073	2136	4016	2637	4807	3137	5659
16	800	1317	2564	1797	3278	2278	4284	2812	5128	3347	6036
17	850	1399	2724	1910	3483	2420	4552	2988	5448	3556	6414
18	900	1481	2885	2022	3688	2563	4820	3164	5769	3765	6791
19	950	1564	3045	2134	3893	2705	5087	3340	6089	3974	7168
20	1000	1646	3205	2247	4097	2848	5355	3515	6410	4183	7546
21	1050	1728	3365	2359	4302	2990	5623	3691	6730	4392	7923
22	1100	1811	3526	2471	4507	3132	5891	3867	7051	4602	8300
23	1150	1893	3686	2584	4712	3275	6158	4043	7371	4811	8677
24	1200	1975	3846	2696	4917	3417	6426	4218	7692	5020	9055
25	1250	2058	4007	2809	5122	3560	6694	4394	8012	5229	9432
26	1300	2140	4167	2921	5327	3702	6962	4570	8332	5438	9809
27	1350	2222	4327	3033	5531	3844	7229	4746	8653	5647	10187
28	1400	2304	4487	3146	5736	3987	7497	4922	8973	5856	10564
29	1450	2387	4648	3258	5941	4129	7765	5097	9294	6066	10941
30	1500	2469	4808	3370	6146	4271	8033	5273	9614	6275	11318
31	1550	2551	4968	3483	6351	4414	8300	5449	9935	6484	11696
32	1600	2634	5128	3595	6556	4556	8568	5625	10255	6693	12073
33	1650	2716	5289	3707	6761	4699	8836	5800	10576	6902	12450
34	1700	2798	5449	3820	6966	4841	9104	5976	10896	7111	12828
35	1750	2881	5609	3932	7170	4983	9371	6152	11217	7321	13205
36	1800	2963	5769	4044	7375	5126	9639	6328	11537	7530	13582
37	1850	3045	5930	4157	7580	5268	9907	6503	11858	7739	13959
38	1900	3127	6090	4269	7785	5410	10175	6679	12178	7948	14337
39	1950	3210	6250	4381	7990	5553	10442	6855	12499	8157	14714
40	2000	3292	6410	4494	8195	5695	10710	7031	12819	8366	15091
41	2050	3374	6571	4606	8400	5838	10978	7207	13140	8576	15468
42	2100	3457	6731	4718	8605	5980	11246	7382	13460	8785	15846
43	2150	3539	6891	4831	8809	6122	11513	7558	13781	8994	16223
44	2200	3621	7051	4943	9014	6265	11781	7734	14101	9203	16600
45	2250	3704	7212	5055	9219	6407	12049	7910	14422	9412	16978
46	2300	3786	7372	5168	9424	6549	12317	8085	14742	9621	17355
47	2350	3868	7532	5280	9629	6692	12584	8261	15063	9831	17732
48	2400	3950	7692	5392	9834	6834	12852	8437	15383	10040	18109
49	2450	4033	7853	5505	10039	6977	13120	8613	15704	10249	18487
50	2500	4115	8013	5617	10244	7119	13388	8789	16024	10458	18864

Moc cieplna grzejników [W] wg normy EN 442 dla parametrów 75/65/20 °C. PKWU 25.21.11.0; CN 2020 7322 1900. Ceny netto w zł bez podatku VAT.

26 LASERLINE STANDARD

Ceny i wydajność cieplna

Product Class D12000 Item Group OOD90A ETIM Class EC003539

dane techniczne / ceny netto													
Ceny nie zawierają zamocowań. Niebieskie ceny dostawa możliwa w jednym bloku.													
 wysokość [mm] 1200	2-kolumnowy		3-kolumnowy		4-kolumnowy		5-kolumnowy		6-kolumnowy				
	 rozstaw króćców 1135 mm		 63 mm		 101 mm		 139 mm		177 mm		215 mm		
typ	2120		3120		4120		5120		6120				
wykładnik n	1,2823		1,3101		1,3378		1,3350		1,3321				
poj. wody/człon w l	1,19		1,73		2,27		2,80		3,33				
waga/człon w kg	1,90		2,81		3,74		4,65		5,58				
człony	 dtu- gość [mm]	[W]		PLN		[W]		PLN		[W]		PLN	
		[W]	PLN	[W]	PLN	[W]	PLN	[W]	PLN	[W]	PLN		
4	200	357	706	487	941	616	1185	761	1460	905	1712		
5	250	447	882	609	1176	770	1481	951	1826	1131	2140		
6	300	536	1059	730	1412	924	1777	1141	2191	1358	2568		
7	350	625	1235	852	1647	1078	2073	1331	2556	1584	2996		
8	400	715	1412	974	1882	1232	2369	1521	2921	1810	3424		
9	450	804	1588	1095	2118	1386	2665	1712	3286	2037	3852		
10	500	894	1765	1217	2353	1540	2962	1902	3651	2263	4280		
11	550	983	1941	1339	2588	1694	3258	2092	4016	2489	4708		
12	600	1072	2118	1460	2823	1848	3554	2282	4381	2715	5136		
13	650	1162	2294	1582	3059	2003	3850	2472	4746	2942	5564		
14	700	1251	2471	1704	3294	2157	4146	2662	5112	3168	5992		
15	750	1340	2647	1826	3529	2311	4442	2853	5477	3394	6420		
16	800	1430	2824	1947	3764	2465	4738	3043	5842	3621	6848		
17	850	1519	3000	2069	4000	2619	5035	3233	6207	3847	7276		
18	900	1608	3177	2191	4235	2773	5331	3423	6572	4073	7704		
19	950	1698	3353	2312	4470	2927	5627	3613	6937	4300	8132		
20	1000	1787	3530	2434	4706	3081	5923	3803	7302	4526	8560		
21	1050	1876	3706	2556	4941	3235	6219	3994	7667	4752	8988		
22	1100	1966	3883	2677	5176	3389	6515	4184	8032	4978	9416		
23	1150	2055	4059	2799	5411	3543	6811	4374	8398	5205	9844		
24	1200	2144	4236	2921	5647	3697	7108	4564	8763	5431	10272		
25	1250	2234	4412	3043	5882	3851	7404	4754	9128	5657	10700		
26	1300	2323	4589	3164	6117	4005	7700	4944	9493	5884	11128		
27	1350	2412	4765	3286	6353	4159	7996	5135	9858	6110	11556		
28	1400	2502	4942	3408	6588	4313	8292	5325	10223	6336	11984		
29	1450	2591	5118	3529	6823	4467	8588	5515	10588	6562	12412		
30	1500	2681	5295	3651	7058	4621	8885	5705	10953	6789	12840		
31	1550	2770	5471	3773	7294	4775	9181	5895	11318	7015	13268		
32	1600	2859	5648	3894	7529	4929	9477	6085	11684	7241	13696		
33	1650	2949	5824	4016	7764	5083	9773	6276	12049	7468	14124		
34	1700	3038	6001	4138	8000	5237	10069	6466	12414	7694	14552		
35	1750	3127	6177	4260	8235	5391	10365	6656	12779	7920	14980		
36	1800	3217	6354	4381	8470	5545	10661	6846	13144	8146	15408		
37	1850	3306	6530	4503	8705	5699	10958	7036	13509	8373	15836		
38	1900	3395	6707	4625	8941	5854	11254	7226	13874	8599	16264		
39	1950	3485	6883	4746	9176	6008	11550	7417	14239	8825	16692		
40	2000	3574	7060	4868	9411	6162	11846	7607	14604	9052	17120		
41	2050	3663	7236	4990	9646	6316	12142	7797	14970	9278	17548		
42	2100	3753	7413	5111	9882	6470	12438	7987	15335	9504	17976		
43	2150	3842	7589	5233	10117	6624	12734	8177	15700	9730	18404		
44	2200	3931	7766	5355	10352	6778	13031	8367	16065	9957	18832		
45	2250	4021	7942	5477	10588	6932	13327	8558	16430	10183	19260		
46	2300	4110	8119	5598	10823	7086	13623	8748	16795	10409	19688		
47	2350	4199	8295	5720	11058	7240	13919	8938	17160	10636	20116		
48	2400	4289	8472	5842	11293	7394	14215	9128	17525	10862	20544		
49	2450	4378	8648	5963	11529	7548	14511	9318	17890	11088	20972		
50	2500	4468	8825	6085	11764	7702	14808	9509	18256	11315	21400		

Moc cieplna grzejników [W] wg normy EN 442 dla parametrów 75/65/20 °C. PKWiU 25.21.11.0; CN 2020 7322 1900. Ceny netto w zł bez podatku VAT.

Product Class D12000 Item Group OOD90A ETIM Class ECO03539

dane techniczne / ceny netto

Ceny nie zawierają zamocowań. **Niebieskie ceny:** dostawa możliwa w jednym bloku.

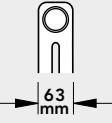
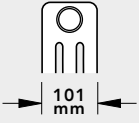
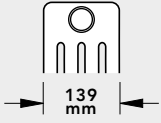
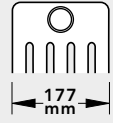
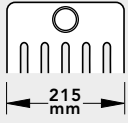

wysokość [mm] 1500	2-kolumnowy		3-kolumnowy		4-kolumnowy		5-kolumnowy		6-kolumnowy		
											
rozstaw króćców 1435 mm											
typ	2150		3150		4150		5150		6150		
wyktadnik n	1,3023		1,3264		1,3504		1,3469		1,3433		
poj. wody/człon w l	1,46		2,11		2,77		3,42		4,08		
waga/człon w kg	2,36		3,49		4,64		5,77		6,92		
człony	długość [mm]	[W]		[W]		[W]		[W]		[W]	
		PLN	PLN	PLN	PLN	PLN	PLN	PLN	PLN	PLN	
4	200	443	893	599	1225	756	1599	933	1972	1110	2353
5	250	553	1116	749	1531	945	1998	1166	2465	1387	2941
6	300	664	1339	899	1838	1134	2398	1399	2957	1664	3529
7	350	774	1562	1049	2144	1323	2797	1632	3450	1942	4118
8	400	885	1785	1198	2450	1512	3197	1865	3943	2219	4706
9	450	996	2008	1348	2757	1701	3597	2099	4436	2497	5294
10	500	1106	2231	1498	3063	1890	3996	2332	4929	2774	5882
11	550	1217	2454	1648	3369	2078	4396	2565	5422	3052	6471
12	600	1328	2678	1798	3675	2267	4796	2798	5915	3329	7059
13	650	1438	2901	1947	3982	2456	5195	3031	6408	3606	7647
14	700	1549	3124	2097	4288	2645	5595	3265	6901	3884	8235
15	750	1660	3347	2247	4594	2834	5994	3498	7394	4161	8824
16	800	1770	3570	2397	4900	3023	6394	3731	7886	4439	9412
17	850	1881	3793	2547	5207	3212	6794	3964	8379	4716	10000
18	900	1992	4016	2696	5513	3401	7193	4197	8872	4993	10588
19	950	2102	4239	2846	5819	3590	7593	4430	9365	5271	11177
20	1000	2213	4463	2996	6126	3779	7993	4664	9858	5548	11765
21	1050	2323	4686	3146	6432	3968	8392	4897	10351	5826	12353
22	1100	2434	4909	3296	6738	4157	8792	5130	10844	6103	12941
23	1150	2545	5132	3445	7044	4346	9191	5363	11337	6380	13530
24	1200	2655	5355	3595	7351	4535	9591	5596	11830	6658	14118
25	1250	2766	5578	3745	7657	4724	9991	5830	12323	6935	14706
26	1300	2877	5801	3895	7963	4913	10390	6063	12815	7213	15294
27	1350	2987	6025	4045	8270	5102	10790	6296	13308	7490	15882
28	1400	3098	6248	4194	8576	5291	11190	6529	13801	7767	16471
29	1450	3209	6471	4344	8882	5480	11589	6762	14294	8045	17059
30	1500	3319	6694	4494	9188	5669	11989	6995	14787	8322	17647
31	1550	3430	6917	4644	9495	5857	12389	7229	15280	8600	18235
32	1600	3540	7140	4794	9801	6046	12788	7462	15773	8877	18824
33	1650	3651	7363	4943	10107	6235	13188	7695	16266	9155	19412
34	1700	3762	7586	5093	10414	6424	13587	7928	16759	9432	20000
35	1750	3872	7810	5243	10720	6613	13987	8161	17252	9709	20588
36	1800	3983	8033	5393	11026	6802	14387	8394	17744	9987	21177
37	1850	4094	8256	5543	11332	6991	14786	8628	18237	10264	21765
38	1900	4204	8479	5692	11639	7180	15186	8861	18730	10542	22353
39	1950	4315	8702	5842	11945	7369	15586	9094	19223	10819	22941
40	2000	4426	8925	5992	12251	7558	15985	9327	19716	11096	23530
41	2050	4536	9148	6142	12557	7747	16385	9560	20209	11374	24118
42	2100	4647	9371	6292	12864	7936	16784	9794	20702	11651	24706
43	2150	4758	9595	6441	13170	8125	17184	10027	21195	11929	25294
44	2200	4868	9818	6591	13476	8314	17584	10260	21688	12206	25883
45	2250	4979	10041	6741	13783	8503	17983	10493	22181	12483	26471
46	2300	5089	10264	6891	14089	8692	18383	10726	22673	12761	27059
47	2350	5200	10487	7041	14395	8881	18783	10959	23166	13038	27647
48	2400	5311	10710	7190	14701	9070	19182	11193	23659	13316	28235
49	2450	5421	10933	7340	15008	9259	19582	11426	24152	13593	28824
50	2500	5532	11157	7490	15314	9448	19982	11659	24645	13871	29412

Moc cieplna grzejników [W] wg normy EN 442 dla parametrów 75/65/20 °C. PKWU 25.21.11.0; CN 2020 7322 1900. Ceny netto w zł bez podatku VAT.

28 LASERLINE STANDARD

Ceny i wydajność cieplna

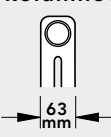
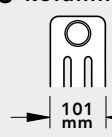
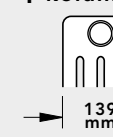
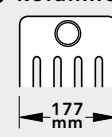
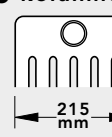
Product Class D12000 Item Group OOD90A ETIM Class EC003539

dane techniczne / ceny netto												
Ceny nie zawierają zamocowań. Niebieskie ceny dostawa możliwa w jednym bloku.												
wysokość [mm] 1800	2-kolumnowy		3-kolumnowy		4-kolumnowy		5-kolumnowy		6-kolumnowy			
	 63 mm		 101 mm		 139 mm		 177 mm		 215 mm			
rozstaw króćców 1735 mm	2180		3180		4180		5180		6180			
typ	1,3197		1,3369		1,3541		1,3504		1,3467			
wykładnik n	1,72		2,49		3,27		4,04		4,82			
poj. wody/człon w l	2,82		4,17		5,53		6,88		8,25			
waga/człon w kg	człony	 dtu- gość [mm]	[W]		[W]		[W]		[W]		[W]	
			PLN	PLN	PLN	PLN	PLN	PLN	PLN	PLN	PLN	
4	200	529	1030	712	1501	896	1915	1105	2345	1313	2783	
5	250	661	1288	890	1876	1120	2394	1381	2931	1642	3479	
6	300	793	1546	1068	2252	1344	2872	1657	3517	1970	4175	
7	350	926	1803	1247	2627	1567	3351	1933	4103	2298	4870	
8	400	1058	2061	1425	3002	1791	3830	2209	4690	2627	5566	
9	450	1190	2318	1603	3377	2015	4308	2485	5276	2955	6262	
10	500	1322	2576	1781	3753	2239	4787	2761	5862	3284	6958	
11	550	1455	2834	1959	4128	2463	5266	3038	6448	3612	7653	
12	600	1587	3091	2137	4503	2687	5745	3314	7034	3940	8349	
13	650	1719	3349	2315	4878	2911	6223	3590	7621	4269	9045	
14	700	1851	3607	2493	5254	3135	6702	3866	8207	4597	9741	
15	750	1983	3864	2671	5629	3359	7181	4142	8793	4925	10436	
16	800	2116	4122	2849	6004	3583	7660	4418	9379	5254	11132	
17	850	2248	4379	3027	6379	3807	8138	4694	9965	5582	11828	
18	900	2380	4637	3205	6755	4031	8617	4971	10552	5910	12524	
19	950	2512	4895	3384	7130	4254	9096	5247	11138	6239	13219	
20	1000	2645	5152	3562	7505	4478	9574	5523	11724	6567	13915	
21	1050	2777	5410	3740	7880	4702	10053	5799	12310	6895	14611	
22	1100	2909	5667	3918	8256	4926	10532	6075	12896	7224	15307	
23	1150	3041	5925	4096	8631	5150	11011	6351	13483	7552	16002	
24	1200	3174	6183	4274	9006	5374	11489	6627	14069	7880	16698	
25	1250	3306	6440	4452	9381	5598	11968	6904	14655	8209	17394	
26	1300	3438	6698	4630	9757	5822	12447	7180	15241	8537	18090	
27	1350	3570	6955	4808	10132	6046	12925	7456	15827	8865	18785	
28	1400	3702	7213	4986	10507	6270	13404	7732	16414	9194	19481	
29	1450	3835	7471	5164	10882	6494	13883	8008	17000	9522	20177	
30	1500	3967	7728	5342	11258	6718	14362	8284	17586	9851	20873	
31	1550	4099	7986	5520	11633	6942	14840	8560	18172	10179	21568	
32	1600	4231	8244	5699	12008	7165	15319	8836	18758	10507	22264	
33	1650	4364	8501	5877	12383	7389	15798	9113	19345	10836	22960	
34	1700	4496	8759	6055	12759	7613	16276	9389	19931	11164	23656	
35	1750	4628	9016	6233	13134	7837	16755	9665	20517	11492	24351	
36	1800	4760	9274	6411	13509	8061	17234	9941	21103	11821	25047	
37	1850	4893	9532	6589	13884	8285	17713	10217	21689	12149	25743	
38	1900	5025	9789	6767	14260	8509	18191	10493	22276	12477	26439	
39	1950	5157	10047	6945	14635	8733	18670	10769	22862	12806	27134	
40	2000	5289	10304	7123	15010	8957	19149	11046	23448	13134	27830	
41	2050	5421	10562	7301	15385	9181	19628	11322	24034	13462	28526	
42	2100	5554	10820	7479	15761	9405	20106	11598	24620	13791	29222	
43	2150	5686	11077	7657	16136	9629	20585	11874	25207	14119	29917	
44	2200	5818	11335	7836	16511	9852	21064	12150	25793	14447	30613	
45	2250	5950	11592	8014	16886	10076	21542	12426	26379	14776	31309	
46	2300	6083	11850	8192	17262	10300	22021	12702	26965	15104	32005	
47	2350	6215	12108	8370	17637	10524	22500	12979	27551	15432	32700	
48	2400	6347	12365	8548	18012	10748	22979	13255	28138	15761	33396	
49	2450	6479	12623	8726	18387	10972	23457	13531	28724	16089	34092	
50	2500	6612	12881	8904	18763	11196	23936	13807	29310	16418	34788	

Moc cieplna grzejników [W] wg normy EN 442 dla parametrów 75/65/20 °C. PKWiU 25.21.11.0; CN 2020 7322 1900. Ceny netto w zł bez podatku VAT.

Product Class D12000 Item Group OOD90A ETIM Class ECO03539

dane techniczne / ceny netto

Ceny nie zawierają zamocowań. **Niebieskie ceny:** dostawa możliwa w jednym bloku.

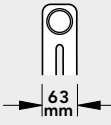
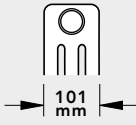
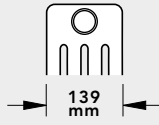
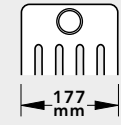
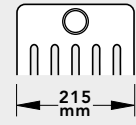
wysokość [mm] 2000	2-kolumnowy		3-kolumnowy		4-kolumnowy		5-kolumnowy		6-kolumnowy		
											
rozstaw króćców 1935 mm	63 mm		101 mm		139 mm		177 mm		215 mm		
typ	2200		3200		4200		5200		6200		
wyktadnik n	1,3289		1,3408		1,3526		1,3486		1,3446		
poj. wody/człon w l	1,90		2,75		3,61		4,46		5,31		
waga/człon w kg	3,12		4,62		6,13		7,63		9,15		
człony	↔ długość [mm]	[W]	PLN	[W]	PLN	[W]	PLN	[W]	PLN	[W]	PLN
4	200	587	1152	788	1615	989	2118	1219	2621	1449	3099
5	250	734	1440	986	2018	1237	2647	1524	3276	1812	3874
6	300	881	1728	1183	2422	1484	3177	1829	3931	2174	4649
7	350	1028	2016	1380	2826	1732	3706	2134	4586	2536	5424
8	400	1175	2304	1577	3229	1979	4235	2439	5241	2899	6199
9	450	1321	2592	1774	3633	2226	4765	2744	5897	3261	6974
10	500	1468	2880	1971	4037	2474	5294	3049	6552	3623	7749
11	550	1615	3168	2168	4440	2721	5824	3353	7207	3986	8523
12	600	1762	3456	2365	4844	2968	6353	3658	7862	4348	9298
13	650	1909	3744	2562	5247	3216	6883	3963	8517	4710	10073
14	700	2056	4032	2759	5651	3463	7412	4268	9173	5073	10848
15	750	2202	4320	2957	6055	3710	7941	4573	9828	5435	11623
16	800	2349	4608	3154	6458	3958	8471	4878	10483	5797	12398
17	850	2496	4897	3351	6862	4205	9000	5182	11138	6160	13173
18	900	2643	5185	3548	7266	4452	9530	5487	11793	6522	13947
19	950	2790	5473	3745	7669	4700	10059	5792	12448	6884	14722
20	1000	2937	5761	3942	8073	4947	10589	6097	13104	7247	15497
21	1050	3083	6049	4139	8477	5195	11118	6402	13759	7609	16272
22	1100	3230	6337	4336	8880	5442	11647	6707	14414	7971	17047
23	1150	3377	6625	4533	9284	5689	12177	7012	15069	8334	17822
24	1200	3524	6913	4730	9688	5937	12706	7316	15724	8696	18597
25	1250	3671	7201	4928	10091	6184	13236	7621	16380	9059	19372
26	1300	3818	7489	5125	10495	6431	13765	7926	17035	9421	20146
27	1350	3964	7777	5322	10899	6679	14295	8231	17690	9783	20921
28	1400	4111	8065	5519	11302	6926	14824	8536	18345	10146	21696
29	1450	4258	8353	5716	11706	7173	15353	8841	19000	10508	22471
30	1500	4405	8641	5913	12110	7421	15883	9146	19655	10870	23246
31	1550	4552	8929	6110	12513	7668	16412	9450	20311	11233	24021
32	1600	4699	9217	6307	12917	7916	16942	9755	20966	11595	24796
33	1650	4845	9505	6504	13320	8163	17471	10060	21621	11957	25570
34	1700	4992	9793	6701	13724	8410	18001	10365	22276	12320	26345
35	1750	5139	10081	6899	14128	8658	18530	10670	22931	12682	27120
36	1800	5286	10369	7096	14531	8905	19059	10975	23586	13044	27895
37	1850	5433	10657	7293	14935	9152	19589	11279	24242	13407	28670
38	1900	5580	10945	7490	15339	9400	20118	11584	24897	13769	29445
39	1950	5726	11233	7687	15742	9647	20648	11889	25552	14131	30220
40	2000	5873	11521	7884	16146	9894	21177	12194	26207	14494	30994
41	2050	6020	11809	8081	16550	10142	21707	12499	26862	14856	31769
42	2100	6167	12097	8278	16953	10389	22236	12804	27518	15218	32544
43	2150	6314	12385	8475	17357	10636	22765	13109	28173	15581	33319
44	2200	6461	12673	8672	17761	10884	23295	13413	28828	15943	34094
45	2250	6607	12961	8870	18164	11131	23824	13718	29483	16305	34869
46	2300	6754	13249	9067	18568	11379	24354	14023	30138	16668	35644
47	2350	6901	13537	9264	18972	11626	24883	14328	30793	17030	36418
48	2400	7048	13825	9461	19375	11873	25413	14633	31449	17392	37193
49	2450	7195	14113	9658	19779	12121	25942	14938	32104	17755	37968
50	2500	7342	14402	9855	20183	12368	26472	15243	32759	18117	38743

Standard

30 LASERLINE STANDARD

Ceny i wydajność cieplna

Product Class D12000 Item Group OOD90A ETIM Class ECO03539

dane techniczne / ceny netto

Ceny nie zawierają zamocowań. **Niebieskie ceny:** dostawa możliwa w jednym bloku.

wysokość [mm] 2200		2-kolumnowy		3-kolumnowy		4-kolumnowy		5-kolumnowy		6-kolumnowy	
rozstaw króćców 2135 mm											
typ		2220		3220		4220		5220		6220	
wykładnik n		1,3356		1,3421		1,3485		1,3437		1,3389	
poj. wody/człon w l		2,08		3,01		3,94		4,87		5,81	
waga/człon w kg		3,43		5,07		6,73		8,38		10,04	
człony	długość [mm]	[W]	PLN	[W]	PLN	[W]	PLN	[W]	PLN	[W]	PLN
4	200	647	1290	865	1826	1084	2361	1335	2897	1586	3416
5	250	808	1613	1081	2282	1355	2951	1668	3621	1982	4270
6	300	970	1935	1298	2738	1626	3542	2002	4345	2379	5124
7	350	1131	2258	1514	3195	1897	4132	2336	5069	2775	5978
8	400	1293	2580	1730	3651	2167	4722	2669	5793	3171	6832
9	450	1455	2903	1947	4108	2438	5312	3003	6517	3568	7686
10	500	1616	3225	2163	4564	2709	5903	3337	7242	3964	8540
11	550	1778	3548	2379	5020	2980	6493	3670	7966	4361	9394
12	600	1940	3870	2595	5477	3251	7083	4004	8690	4757	10248
13	650	2101	4193	2812	5933	3522	7673	4338	9414	5153	11102
14	700	2263	4516	3028	6390	3793	8264	4672	10138	5550	11956
15	750	2424	4838	3244	6846	4064	8854	5005	10862	5946	12810
16	800	2586	5161	3460	7302	4335	9444	5339	11586	6343	13664
17	850	2748	5483	3677	7759	4606	10034	5673	12311	6739	14518
18	900	2909	5806	3893	8215	4877	10625	6006	13035	7136	15372
19	950	3071	6128	4109	8672	5148	11215	6340	13759	7532	16226
20	1000	3233	6451	4326	9128	5419	11805	6674	14483	7928	17080
21	1050	3394	6773	4542	9584	5690	12395	7007	15207	8325	17934
22	1100	3556	7096	4758	10041	5960	12986	7341	15931	8721	18788
23	1150	3717	7418	4974	10497	6231	13576	7675	16655	9118	19642
24	1200	3879	7741	5191	10954	6502	14166	8008	17380	9514	20496
25	1250	4041	8064	5407	11410	6773	14756	8342	18104	9911	21350

Ceny nie zawierają zamocowań. **Niebieskie ceny:** dostawa możliwa w jednym bloku.

wysokość [mm] 2500		2-kolumnowy		3-kolumnowy		4-kolumnowy		5-kolumnowy		6-kolumnowy	
rozstaw króćców 2435 mm											
typ		2250		3250		4250		5250		6250	
wykładnik n		1,3398		1,3393		1,3387		1,3312		1,3236	
poj. wody/człon w l		2,34		3,39		4,45		5,50		6,55	
waga/człon w kg		3,89		5,75		7,63		9,49		11,37	
człony	długość [mm]	[W]	PLN	[W]	PLN	[W]	PLN	[W]	PLN	[W]	PLN
4	200	737	1452	982	2069	1227	2661	1509	3254	1791	3878
5	250	921	1815	1227	2586	1533	3327	1886	4067	2239	4848
6	300	1105	2178	1473	3103	1840	3992	2263	4880	2687	5818
7	350	1290	2541	1718	3621	2146	4657	2640	5694	3134	6787
8	400	1474	2905	1964	4138	2453	5322	3018	6507	3582	7757
9	450	1658	3268	2209	4655	2760	5988	3395	7320	4030	8726
10	500	1842	3631	2454	5172	3066	6653	3772	8134	4478	9696
11	550	2027	3994	2700	5690	3373	7318	4149	8947	4926	10666
12	600	2211	4357	2945	6207	3680	7984	4527	9761	5373	11635
13	650	2395	4720	3191	6724	3986	8649	4904	10574	5821	12605
14	700	2579	5083	3436	7241	4293	9314	5281	11387	6269	13574
15	750	2763	5446	3682	7758	4600	9980	5658	12201	6717	14544
16	800	2948	5809	3927	8276	4906	10645	6035	13014	7164	15514
17	850	3132	6172	4172	8793	5213	11310	6413	13827	7612	16483
18	900	3316	6535	4418	9310	5520	11975	6790	14641	8060	17453
19	950	3500	6898	4663	9827	5826	12641	7167	15454	8508	18422
20	1000	3685	7261	4909	10345	6133	13306	7544	16268	8956	19392
21	1050	3869	7624	5154	10862	6439	13971	7921	17081	9403	20362
22	1100	4053	7988	5400	11379	6746	14637	8299	17894	9851	21331
23	1150	4237	8351	5645	11896	7053	15302	8676	18708	10299	22301
24	1200	4422	8714	5891	12414	7359	15967	9053	19521	10747	23270
25	1250	4606	9077	6136	12931	7666	16633	9430	20335	11195	24240

Moc cieplna grzejników [W] wg normy EN 442 dla parametrów 75/65/20 °C. PKWiU 25.21.11.0; CN 2020 7322 1900. Ceny netto w zł bez podatku VAT.

Product Class D12000 Item Group OOD90A ETIM Class ECO03539

dane techniczne / ceny netto

Ceny nie zawierają zamocowań. **Niebieskie ceny**: dostawa możliwa w jednym bloku.

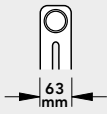
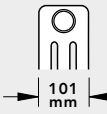
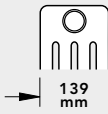
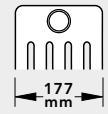
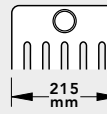
wysokość [mm]		2-kolumnowy		3-kolumnowy		4-kolumnowy		5-kolumnowy		6-kolumnowy	
2800											
rozstaw króćców 2735 mm		63 mm		101 mm		139 mm		177 mm		215 mm	
typ		2280		3280		4280		5280		6280	
wykładnik n		1,3354		1,3307		1,3260		1,3131		1,3002	
poj. wody/człon w l		2,61		3,78		4,95		6,12		7,29	
waga/człon w kg		4,34		6,43		8,53		10,61		12,71	
człony	długość [mm]	[W]	PLN	[W]	PLN	[W]	PLN	[W]	PLN	[W]	PLN
4	200	829	1590	1100	2321	1371	3010	1685	3611	1998	4349
5	250	1037	1988	1375	2901	1714	3763	2106	4513	2498	5436
6	300	1244	2385	1651	3481	2057	4515	2527	5416	2997	6523
7	350	1452	2783	1926	4061	2400	5268	2948	6319	3497	7611
8	400	1659	3180	2201	4641	2743	6020	3369	7221	3996	8698
9	450	1866	3578	2476	5221	3085	6773	3791	8124	4496	9785
10	500	2074	3976	2751	5801	3428	7525	4212	9027	4995	10872
11	550	2281	4373	3026	6382	3771	8278	4633	9929	5495	11959
12	600	2488	4771	3301	6962	4114	9030	5054	10832	5994	13047
13	650	2696	5168	3576	7542	4457	9783	5475	11735	6494	14134
14	700	2903	5566	3851	8122	4799	10535	5897	12637	6993	15221
15	750	3110	5963	4126	8702	5142	11288	6318	13540	7493	16308
16	800	3318	6361	4401	9282	5485	12040	6739	14443	7992	17396
17	850	3525	6759	4677	9862	5828	12793	7160	15345	8492	18483
18	900	3732	7156	4952	10443	6171	13546	7581	16248	8992	19570
19	950	3940	7554	5227	11023	6514	14298	8002	17151	9491	20657
20	1000	4147	7951	5502	11603	6856	15051	8424	18053	9991	21744
21	1050	4355	8349	5777	12183	7199	15803	8845	18956	10490	22832
22	1100	4562	8746	6052	12763	7542	16556	9266	19859	10990	23919
23	1150	4769	9144	6327	13343	7885	17308	9687	20761	11489	25006
24	1200	4977	9541	6602	13923	8228	18061	10108	21664	11989	26093
25	1250	5184	9939	6877	14504	8571	18813	10530	22567	12488	27181

Ceny nie zawierają zamocowań. **Niebieskie ceny**: dostawa możliwa w jednym bloku.

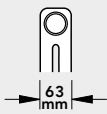
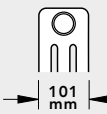
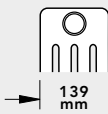
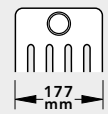
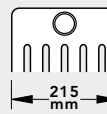
wysokość [mm]		2-kolumnowy		3-kolumnowy		4-kolumnowy		5-kolumnowy		6-kolumnowy	
3000											
rozstaw króćców 2935 mm		63 mm		101 mm		139 mm		177 mm		215 mm	
typ		2300		3300		4300		5300		6300	
wykładnik n		1,3267		1,3218		1,3169		1,2985		1,2800	
poj. wody/człon w l		2,79		4,03		5,29		6,53		7,79	
waga/człon w kg		4,65		6,88		9,12		11,35		13,60	
człony	długość [mm]	[W]	PLN	[W]	PLN	[W]	PLN	[W]	PLN	[W]	PLN
4	200	892	1680	1181	2499	1469	3197	1803	3870	2137	4617
5	250	1116	2099	1476	3124	1836	3996	2254	4838	2672	5771
6	300	1339	2519	1771	3749	2204	4795	2705	5805	3206	6925
7	350	1562	2939	2066	4373	2571	5594	3155	6773	3740	8079
8	400	1785	3359	2361	4998	2938	6394	3606	7740	4274	9233
9	450	2008	3779	2657	5623	3305	7193	4057	8708	4809	10387
10	500	2231	4199	2952	6248	3673	7992	4508	9675	5343	11541
11	550	2454	4619	3247	6872	4040	8791	4959	10643	5877	12696
12	600	2677	5039	3542	7497	4407	9590	5409	11610	6412	13850
13	650	2900	5458	3837	8122	4774	10390	5860	12578	6946	15004
14	700	3123	5878	4133	8747	5142	11189	6311	13546	7480	16158
15	750	3347	6298	4428	9371	5509	11988	6762	14513	8015	17312
16	800	3570	6718	4723	9996	5876	12787	7212	15481	8549	18466
17	850	3793	7138	5018	10621	6243	13586	7663	16448	9083	19620
18	900	4016	7558	5313	11246	6611	14386	8114	17416	9617	20775
19	950	4239	7978	5608	11870	6978	15185	8565	18383	10152	21929
20	1000	4462	8398	5904	12495	7345	15984	9016	19351	10686	23083
21	1050	4685	8817	6199	13120	7712	16783	9466	20318	11220	24237
22	1100	4908	9237	6494	13745	8080	17582	9917	21286	11755	25391
23	1150	5131	9657	6789	14369	8447	18382	10368	22253	12289	26545
24	1200	5354	10077	7084	14994	8814	19181	10819	23221	12823	27699
25	1250	5578	10497	7380	15619	9181	19980	11270	24189	13358	28854

Moc cieplna grzejników [W] wg normy EN 442 dla parametrów 75/65/20 °C. PKWiU 25.21.11.0; CN 2020 7322 1900. Ceny netto w zł bez podatku VAT.

32 LASERLINE STANDARD

Specjalne wykonanie

specjalne wykonanie	
opłaty dodatkowe za specjalne wykonanie	dopłata
Grzejnik LaserLine Standard z podłączeniem dolnym w wariantach: VL, VR, CD, DC, ML, MR	442 PLN
wykonanie ocynkowane	100 %
wykonanie kątowe	1026 PLN
wykonanie łukowe za człon	176 PLN
specjalne wysokości między 300 a 3000 mm	cena od następnej standardowej wysokości

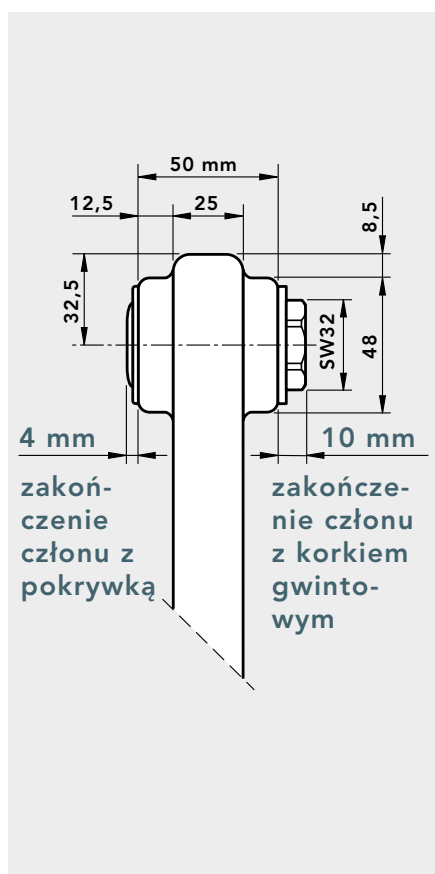

wykonanie kątowe (przedstawione na grzejniku 3-kolumnowym)

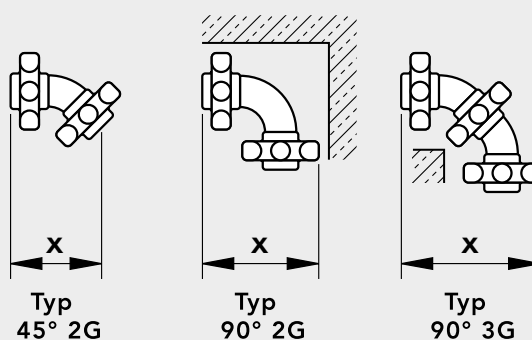

Typ	X [mm]				
	2-kolumnowy	3-kolumnowy	4-kolumnowy	5-kolumnowy	6-kolumnowy
45° 2G	110	120	133	148	163
90° 2G	135	154	190	227	266
90° 3G	152	184	222	262	302

Inne wykonanie kątowe na zapytanie.

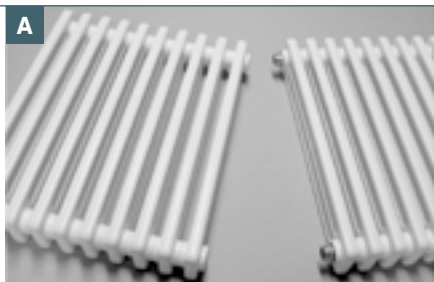

Położyć dwa bloki grzejnika na płaskim podłożu.

Starannie usunąć resztki farby i zanieczyszczeń w miejscach uszczelnienia i na powierzchni króćców przyłączeniowych. Używać tylko oryginalnych LaserLine nypli połączeniowych i uszczeltek. Wkręcić obydwa nyple na około jeden zwoj do obu króćców przyłączeniowych danego bloku, uważać na prawy/ lewy gwint. Gwinty lewoskrętne są radetkowane na zwojach gwintu. Na każdy nypl nałożyć uszczelkę.



Nasadki do nypli dostępne są w długościach 1,0 m; 1,6 m i 2,2 m. Do kompletu wymagany jest także klucz dynamometryczny.

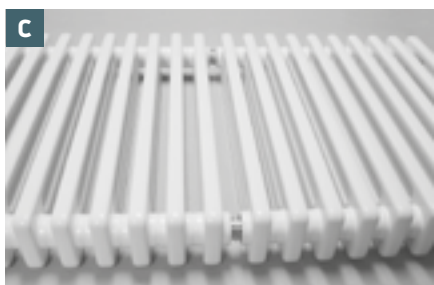

Wsunąć drugi blok na nyple z poprzedniego bloku.



Wprowadzić nasadkę do nypli przez przyłącze ostatniego bloku aż do momentu dojścia do danego nypla. Nasadzić klucz dynamometryczny na czworokątną końcówkę nasadki do nypli.

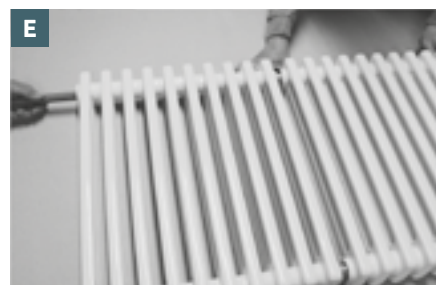

Dokręcać naprzemiennie obydwa nyple za pomocą klucza. Moment obrotowy powinien wynosić 90 +/- 10 Nm. Jednostronnie dokręcony nypl powoduje przeciek.



Podczas użycia ramienia klucza dynamometrycznego o długości 400 mm i ciężarze (przy uchwycie) 22,5 kg, moment obrotowy dokręcania wynosi 90 Nm.

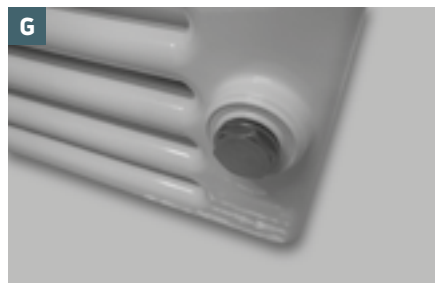

Do długości grzejnika należy doliczyć 15 mm na korek lub odpowietrznik. Moment obrotowy powinien wynosić 45 +/- 10 Nm.



Do długości grzejnika należy również doliczyć dodatkowe 15 mm na redukcję. Moment obrotowy powinien wynosić 45 +/- 10 Nm.



Gotowy grzejnik kolumnowy po połączeniu.

Uwaga!

Tolerancja przy długości dostarczanych grzejników wynosi 0 do +1%. Uwzględnić to przy montażu wstępnym.

Wskazówka:

Przy grzejnikach kolumnowych LaserLine z gotowych bloków i nypli, zwiększa się wymiar długości o 30 mm. (Każdorazowo 15 mm dla korków gwintowych).

długości bloków

W celu ułatwienia wysyłki i transportu grzejników kolumnowych LaserLine, dłuższe grzejniki dostarczają się na miejsce

budowy jako podzielone na mniejsze bloki w wielkości zależnej od typu i wysokości grzejnika.

instrukcja łączenia bloków

Grzejniki kolumnowe dostarczone w oddzielnych blokach łączone są ze sobą na miejscu budowy u klienta, za pomocą nypli połączeniowych. Do uszczelnienia miejsc łączenia bloków należy stosować wyłącznie oryginalne uszczelki. Konopie lub inne środki uszczelniające nie są dozwolone.

Króćce przyłączeniowe poszczególnych bloków i nyple mają gwint 1" –prawoskrętny i lewoskrętny. Po wewnętrznej stronie nypla umieszczone są dwa wgłębienia, w które podczas montażu należy wsunąć nasadkę do skręcania bloków.

Dokładne przestrzeganie instrukcji jest warunkiem skutecznego uszczelnienia miejsc łączenia.

- Ułożyć bloki poziomo na równym, płaskim podłożu. Dla ochrony lakieru przed uszkodzeniami powinno się podłożyć karton lub inną tego typu podkładkę.
- Starannie usunąć resztki farby i zanieczyszczeń w miejscach uszczelnienia i na powierzchni króćców przyłączeniowych.
- Używać tylko oryginalnych nypli LaserLine i uszczelki 1,5 mm (EPDM, białe). Konopie

lub podobne środki uszczelniające są zabronione.

- Obydwa nyple wkręcić na około jeden zwoj do obu króćców przyłączeniowych danego bloku, przy czym uważać na prawy lub lewy gwint (lewe gwinty są radełkowane na zwojach gwintu).
- Na każdy nypl nałożyć po jednej uszczelce ustawionej osiowo na środku.
- Nałożyć kolejny blok na nyple.
- Wprowadzić nasadkę przez wolne przyłącze ostatnio nasadzonego bloku aż do samego nypla połączeniowego. Głębokość osadzenia klucza można zmierzyć wcześniej na zewnątrz i oznaczyć na kluczu. Należy stosować tylko niezawodne, dobre klucze. Na czworokątną końcówkę klucza nasadzić klucz dynamometryczny ułatwiający dokręcanie.
- Dokręcać naprzemiennie obydwie nyple za pomocą klucza. Zapewni to równomierny docisk i pewne uszczelnienie połączeń bloków. Nierównomierne dociąganie prowadzi do powstania nieszczelności. Maksymalny moment obrotowy powinien

wynosić 200 powinien wynosić 90 +/- 10 Nm¹⁾. Nyple i korki gwintowe nie należy dokręcać na siłę. Jednostronnie dokręcone nyple powodują powstanie przecieków.

montaż korków

Po złączeniu poszczególnych bloków grzejnika wkręca się korki gwintowane i podłącza się grzejnik do instalacji. Dostarczane są korki z gwintem prawoskrętnym i lewoskrętnym oraz uszczelki.

Uwaga:

Do długości grzejnika jest dodana długość korka gwintowego (ok. 15 mm na korek).

- Do użycia są dostarczane tylko oryginalne korki gwintowe i 2,6 mm uszczelki (EPDM, białe). Konopie lub inny śro-

dek uszczelniający nie jest dozwolony.

- Sprawdzić czy powierzchnie uszczelniające i gwinty są w nienaruszonym stanie.
- Nałożyć uszczelki na korki gwintowe.
- Korki dokręcić ręcznie, przy czym należy uważać na prawy i lewy gwint. Dopilnować właściwego położenia uszczelki, aby cały przekrój poprzeczny był skutecznie uszczelniony oraz aby uszczelka się nie zdeformowała.
- Do dokręcania końcowego należy użyć tylko odpowiednich narzędzi (klucz płaski, oczkowy lub nasadowy). Mo-

ment obrotowy powinien wynosić 90 +/- 10 Nm¹⁾. Używanie obcęgow lub podobnych narzędzi jest niedopuszczalne.

- Gwint 1" otworów montażowych bloków nie nadaje się do bezpośredniego podłączenia przewodów instalacji grzewczej; dla prawidłowego podłączenia należy stosować korki wkręcane z otworami przyłączeniowymi oraz dostarczone uszczelki.

zawieszenie długiego grzejnika

Grzejniki kolumnowe LaserLine o większych długościach muszą być podniesione pionowo przez co najmniej dwie osoby i osadzone na konsolach ściennych. Aby uniknąć wygięcia grzejnika można w razie potrzeby użyć środków pomocniczych (belki, deski, rury itd.). Uwzględnić koniecznie liczbę konsoli (punkty zawieszenia).

wymiana bloków

Do wymiany bloków używa się tylko oryginalnych, firmowych korków przyłączeniowych, nypli i uszczelki. Wyżej wymienione wskazówki muszą zostać uwzględnione.

¹⁾ przykład

Podczas użycia ramienia klucza o długości 400 mm i ciężarze (przy uchwycie) 22,5 kg, moment dokręcający wynosi 90 Nm.

LASERLINE GRZEJNIK ZAWOROWY



wysokość 155 - 3000 mm
na życzenie klienta możliwa dostawa
każdej wysokości między 300 a
3000 mm z dokładnością milime-
trową.



długość 200 - max. 2500 mm



głębokość
2-kolumnowy: 63 mm
3-kolumnowy: 101 mm
4-kolumnowy: 139 mm
5-kolumnowy: 177 mm
6-kolumnowy: 215 mm



podłączenia
boczne 4 x GW 1/2" z prawej
i lewej strony
dolne 2 x GW 1/2"
odstęp pomiędzy króćcami przyłączenio-
wymi 50 mm z zamontowanym zaworem
termostatycznym u góry



maks. ciśnienie robocze
10 bar



maks. temperatura pracy
110 °C

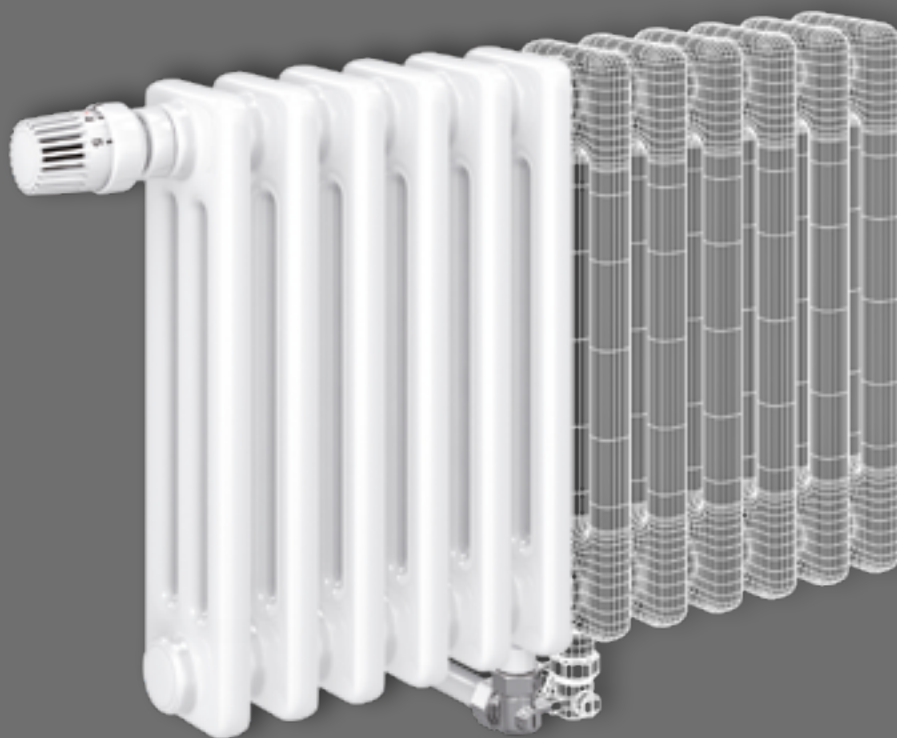

- spawany laserowo - niewidoczne połączenia zgrzewane
- wysoka precyzja produkcji
- optymalne wykonanie ułatwiające czyszczenie

Grzejniki dekoracyjne kolumnowe z precyzyjnej rury stalowej i głowice spawane laserowo. Możliwa jest tylko parzysta liczba członów.

Rury i głowice spłaszczone na stronach zewnętrznych dla podwyższenia mocy cieplnej.

Brak nierówności spawalniczych wewnątrz i na zewnątrz grzejnika.

Z wbudowanym regulowanym zaworem z nastawą wstępną.

Opakowanie

Nieszkodliwe dla środowiska opakowanie transportowe z kartonową osłoną krawędzi, zgrzewane w folii.

Bezpieczeństwo

Konstrukcja odpowiada wymaganiom BHP. Sprawdzone i zarejestrowane według normy EN 442 nr 6R0900.

Dane techniczne

Króciec o średnicy 1", długość członu 50 mm.

Uwaga!

Tolerancja długości dostarczanych grzejników wynosi 0 do +1 %. Uwzględnić to przy montażu wstępnym!

Wskazówka:

Przy grzejnikach kolumnowych LaserLine z gotowych bloków i nypli, zwiększa się wymiar długości o 30 mm. (Każdorazowo 15 mm dla korków gwintowych).

Mocowanie

zobacz akcesoria

Zakres dostawy

Zamontowany zawór termostatyczny pasuje do głowic termostatycznych z przyłączem gwintowym M 30*1,5 mm; zawór odpowietrzający i 2 x spust 1/2".

Powłoka

Według DIN 55 900, z elektroforetycznym gruntowaniem i pokryte wypalonym proszkiem w kolorze śnieżnobiałym RAL 9016, inne kolory z palety RAL i kolory specjalne na zapytanie.

przeгляд typów

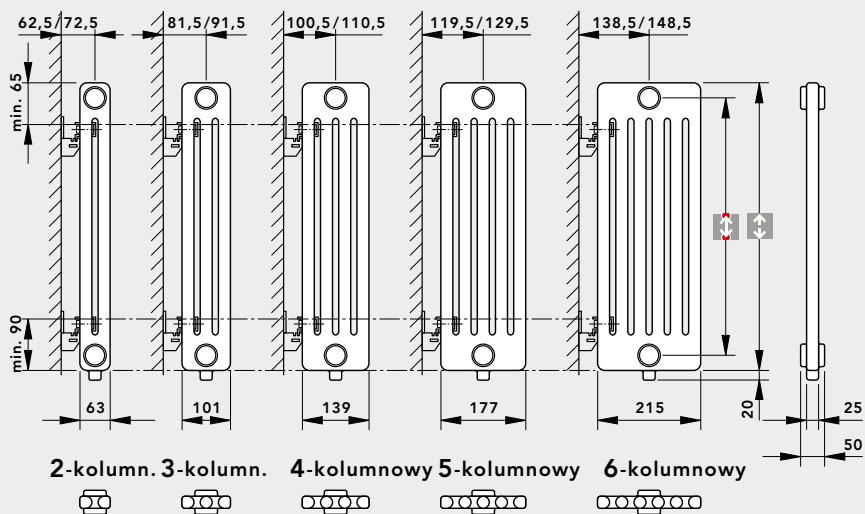

Wskazówka:

Grzejniki kolumnowe zaworowe zawsze dostarczane są bez zamocowań.



wysokość - 65 mm

maksymalna liczba elementów w jednym bloku

↑ ↓ wysokość [mm]	ilość kolumn				
	2	3	4	5	6
155	40	40	40	40	40
300	40	40	40	40	40
350	40	40	40	40	40
365	-	40	40	40	40
400	40	40	40	40	40
415	-	40	40	-	40
450	40	40	40	40	40
500	40	40	40	40	35
550	40	40	40	40	35
565	40	40	40	40	35
600	40	40	40	40	35
665	40	40	40	35	30
750	40	40	40	30	25
900	40	40	30	25	20
965	40	40	30	-	20
1000	40	40	30	25	20
1065	-	19	19	19	16
1100	19	19	19	19	15
1200	19	19	19	19	15
1500	19	19	19	15	13
1800	19	19	14	10	10
2000	19	19	14	10	10
2200	19	19	14	10	8
2500	19	14	10	10	8
2800	19	14	10	8	7
3000	19	14	10	8	7

WAŻNE: Przy zamówieniu grzejnika LaserLine zaworowego o większej liczbie elementów w danym bloku, niż podano w tabeli, dostawa będzie podzielona na 2 lub więcej bloków, które należy zamontować na miejscu budowy u klienta. Złączki i uszczelki dostarczane są razem z blokami bez dopłaty. Do skręcenia bloków wymagany jest odpowiedni klucz do nypli, patrz strona 78, który należy zamówić osobno!

możliwe sposoby podłączenia

Grzejniki kolumnowe LaserLine Zaworowe wyposażone są standardowo w 2 dolne podłączenia z gwintem wewnętrznym GW 1/2":

podłączenie dolne; 1 i 2 element

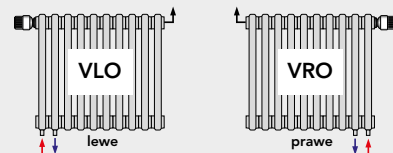

podłączenie dolne; 1 i ostatni element

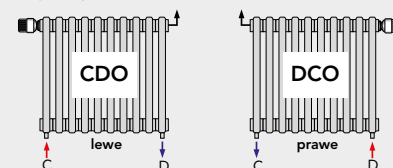

podłączenie dolne; środkowe tylko parzysta ilość elementów! maksymalna liczba członów - 30.

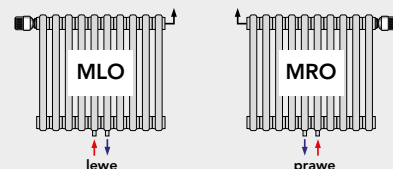

Wskazówka

W zamówieniu należy koniecznie podać wariant podłączenia!

przykład

wariant podłączenia VLO (dolne lewe; 1 i 2 element)

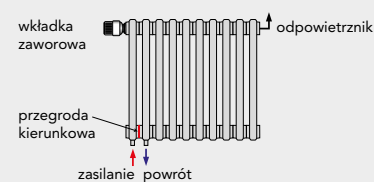

WAŻNE: Przy zamówieniu grzejnika LaserLine zaworowego o większej liczbie elementów w danym bloku, niż podano w tabeli, dostawa będzie podzielona na 2 lub więcej bloków, które należy zamontować na miejscu budowy u klienta. Złączki i uszczelki dostarczane są razem z blokami bez dopłaty. Do skręcenia bloków wymagany jest odpowiedni klucz do nypli, patrz strona 78, który należy zamówić osobno!

instalacja dwururowa

Właściwe wartości nastaw wstępnych można łatwo i dokładnie nastawić **bez** specjalnych narzędzi (patrz szkice poniżej)

Grzejnik dostarczany jest z zamontowaną osłoną zaworu. Po demontażu tej osłony (poz. **1**) mogą być zamontowane bezpośrednio na zaworze (poz. **B**) głowice termostatyczne (poz. **A** nie jest w zakresie dostawy) z przyłączem gwintowym M 30* 1,5 mm firmy Heimeier, Honeywell-

-MNG i Oventrop, względnie specjalne głowice termostatyczne „RAW-K” firmy Danfoss i Herz „H”.

- Wybór nastawy odbywa się w zakresie od 1 do 6
- Zawór jest ustawiony fabrycznie na nastawie wstępnej 6.

Wskazówki ustawienia:

- Zdjąć osłonę zaworu względnie głowicę termostatyczną.
- Obrócić pierścień nastawy w kierunku przeciwnym do ruchu wskazówek zegara. Ustawić żądaną wartość (1-6) na przeciw znacznika.

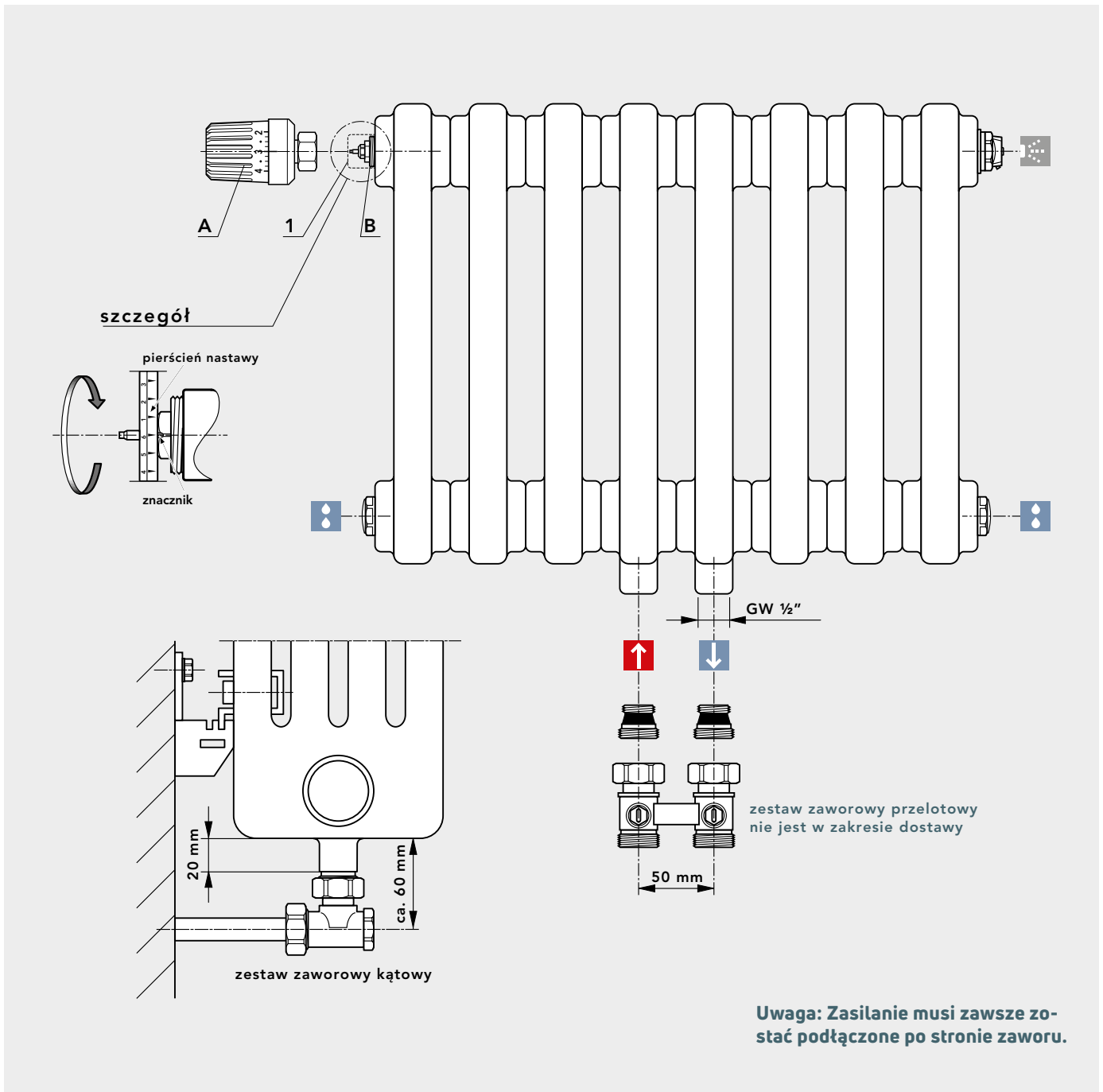

Grzejnik zaworowy

przepływ przy 2 K P-odchylenia

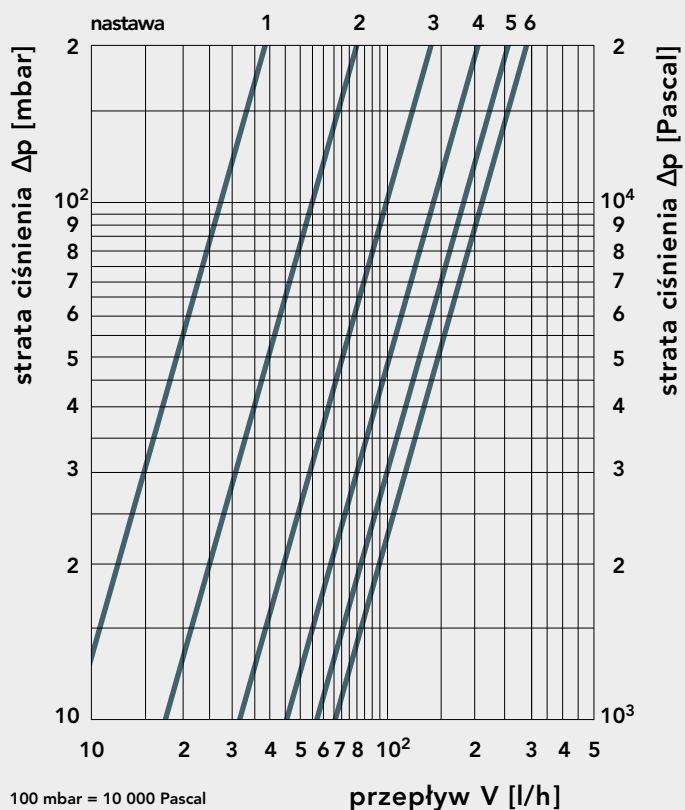

VE*	1	2	3	4	5	6
k_v	0,047	0,126	0,269	0,417	0,6	0,7

*VE = nastawa

Wkładka zaworowa z nastawą wstępną jest fabrycznie zamontowana. Przyłącze gwintowe M 30*1,5 mm. Dostarczane typy grzejników i wydajność cieplna przedstawione są w tabelach na następujących stronach.

przepływ przy nastawie wstępnej 6

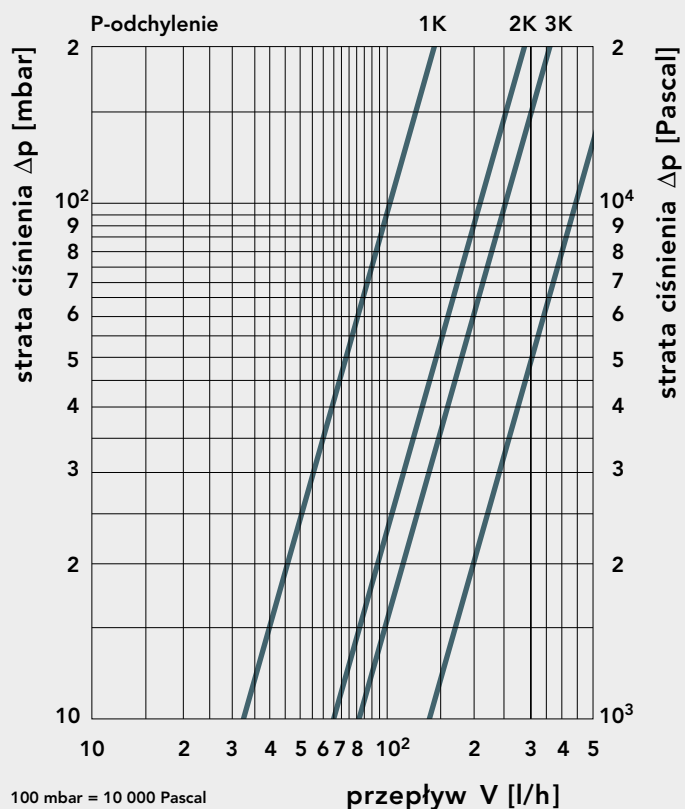

specjalne wykonanie

opłaty dodatkowe za specjalne wykonanie	dopłata
wykonanie ocynkowane	100 %
specjalne wysokości między 300 i 3000 mm	cena od następnej standardowej wysokości

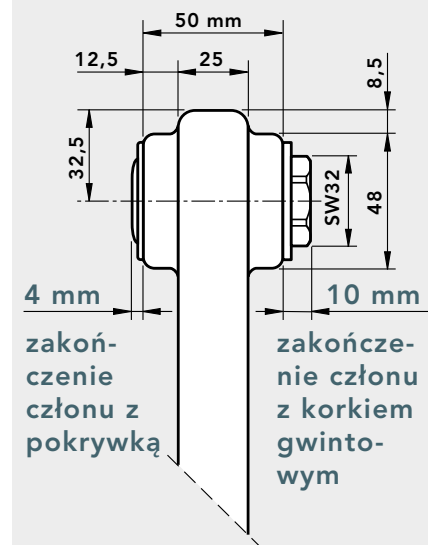

Grzejnik zaworowy

dane techniczne / ceny netto

Uwaga! montaż grzejnika możliwy wyłącznie za pomocą zawieszek WK155 lub stojaków FK5. Ceny nie zawierają zamocowań. **Niebieskie ceny:** dostawa możliwa w jednym bloku.

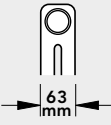
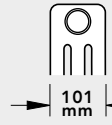
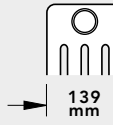
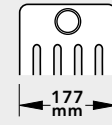
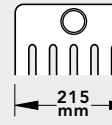
wysokość [mm]		2-kolumnowy		3-kolumnowy		4-kolumnowy		5-kolumnowy		6-kolumnowy	
155											
rozstaw króćców 90 mm											
typ		2016		3016		4016		5016		6016	
wyktadnik n		1,2120		1,2227		1,2222		1,2413		1,2359	
poj. wody/człon w l		0,27		0,39		0,51		0,63		0,75	
waga/człon w kg		0,30		0,45		0,61		0,76		0,93	
człony	długość [mm]	[W]		[W]		[W]		[W]		[W]	
			PLN		PLN		PLN		PLN		PLN
4	200	51	1065	70	1098	91	1163	115	1268	139	1374
5	250	63	1177	88	1217	114	1298	144	1430	174	1562
6	300	76	1289	105	1337	137	1434	172	1593	209	1751
7	350	89	1400	123	1457	160	1570	201	1755	244	1940
8	400	101	1512	140	1576	183	1706	230	1917	278	2128
9	450	114	1623	158	1696	205	1842	258	2080	313	2317
10	500	127	1735	175	1816	228	1978	287	2242	348	2506
11	550	139	1846	193	1935	251	2114	316	2404	383	2694
12	600	152	1958	210	2055	274	2250	345	2566	418	2883
13	650	165	2070	228	2175	297	2386	373	2729	452	3071
14	700	177	2181	245	2294	320	2521	402	2891	487	3260
15	750	190	2293	263	2414	342	2657	431	3053	522	3449
16	800	203	2404	280	2534	365	2793	459	3215	557	3637
17	850	215	2516	298	2653	388	2929	488	3378	592	3826
18	900	228	2628	315	2773	411	3065	517	3540	626	4015
19	950	241	2739	333	2893	434	3201	545	3702	661	4203
20	1000	253	2851	350	3012	457	3337	574	3865	696	4392
21	1050	266	2962	368	3132	479	3473	603	4027	731	4581
22	1100	279	3074	385	3252	502	3609	632	4189	766	4769
23	1150	291	3186	403	3371	525	3744	660	4351	800	4958
24	1200	304	3297	420	3491	548	3880	689	4514	835	5147
25	1250	317	3409	438	3611	571	4016	718	4676	870	5335
26	1300	329	3520	455	3730	594	4152	746	4838	905	5524
27	1350	342	3632	473	3850	616	4288	775	5001	940	5713
28	1400	354	3744	490	3970	639	4424	804	5163	974	5901
29	1450	367	3855	508	4089	662	4560	833	5325	1009	6090
30	1500	380	3967	525	4209	685	4696	861	5487	1044	6279
31	1550	392	4078	543	4329	708	4832	890	5650	1079	6467
32	1600	405	4190	560	4448	731	4967	919	5812	1114	6656
33	1650	418	4301	578	4568	753	5103	947	5974	1148	6844
34	1700	430	4413	595	4688	776	5239	976	6137	1183	7033
35	1750	443	4525	613	4807	799	5375	1005	6299	1218	7222
36	1800	456	4636	630	4927	822	5511	1034	6461	1253	7410
37	1850	468	4748	648	5047	845	5647	1062	6623	1288	7599
38	1900	481	4859	665	5166	868	5783	1091	6786	1322	7788
39	1950	494	4971	683	5286	890	5919	1120	6948	1357	7976
40	2000	506	5083	700	5406	913	6055	1148	7110	1392	8165
41	2050	519	5194	718	5525	936	6190	1177	7272	1427	8354
42	2100	532	5306	735	5645	959	6326	1206	7435	1462	8542
43	2150	544	5417	753	5765	982	6462	1235	7597	1496	8731
44	2200	557	5529	770	5884	1005	6598	1263	7759	1531	8920
45	2250	570	5641	788	6004	1027	6734	1292	7922	1566	9108
46	2300	582	5752	805	6124	1050	6870	1321	8084	1601	9297
47	2350	595	5864	823	6243	1073	7006	1349	8246	1636	9486
48	2400	608	5975	840	6363	1096	7142	1378	8408	1670	9674
49	2450	620	6087	858	6483	1119	7278	1407	8571	1705	9863
50	2500	633	6199	876	6603	1142	7414	1436	8733	1740	10052

Product Class D13000 Item Group OOD90C ETIM Class ECO03539

dane techniczne / ceny netto

Ceny nie zawierają zamocowań. **Niebieskie ceny**: dostawa możliwa w jednym bloku.

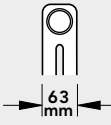
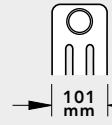
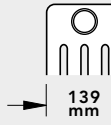
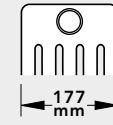
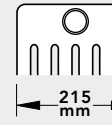



wysokość [mm]		2-kolumnowy		3-kolumnowy		4-kolumnowy		5-kolumnowy		6-kolumnowy	
300											
rozstaw króćców 235 mm											
typ		2030		3030		4030		5030		6030	
wyktadnik n		1,2243		1,2270		1,2297		1,2410		1,2523	
poj. wody/człon w l		0,40		0,57		0,75		0,93		1,11	
waga/człon w kg		0,52		0,78		1,05		1,30		1,57	
człony	długość [mm]	[W]		[W]		[W]		[W]		[W]	
			PLN		PLN		PLN		PLN		PLN
4	200	101	1073	142	1114	182	1171	224	1276	266	1382
5	250	126	1187	177	1238	228	1309	280	1441	332	1572
6	300	151	1300	212	1361	273	1447	336	1605	398	1763
7	350	177	1414	248	1485	319	1585	392	1769	465	1954
8	400	202	1528	283	1609	364	1723	448	1933	531	2144
9	450	227	1641	319	1733	410	1861	504	2098	598	2335
10	500	252	1755	354	1856	456	1999	560	2262	664	2526
11	550	278	1868	389	1980	501	2136	616	2426	730	2716
12	600	303	1982	425	2104	547	2274	672	2591	797	2907
13	650	328	2095	460	2227	592	2412	728	2755	863	3098
14	700	353	2209	496	2351	638	2550	784	2919	929	3288
15	750	379	2323	531	2475	683	2688	840	3084	996	3479
16	800	404	2436	566	2599	729	2826	896	3248	1062	3670
17	850	429	2550	602	2722	775	2964	952	3412	1129	3860
18	900	454	2663	637	2846	820	3102	1008	3576	1195	4051
19	950	480	2777	673	2970	866	3240	1064	3741	1261	4242
20	1000	505	2890	708	3094	911	3378	1120	3905	1328	4432
21	1050	530	3004	743	3217	957	3516	1176	4069	1394	4623
22	1100	555	3118	779	3341	1002	3654	1232	4234	1461	4814
23	1150	581	3231	814	3465	1048	3792	1288	4398	1527	5004
24	1200	606	3345	850	3589	1093	3930	1344	4562	1593	5195
25	1250	631	3458	885	3712	1139	4068	1400	4727	1660	5386
26	1300	656	3572	920	3836	1185	4206	1455	4891	1726	5576
27	1350	681	3685	956	3960	1230	4344	1511	5055	1793	5767
28	1400	707	3799	991	4083	1276	4482	1567	5219	1859	5958
29	1450	732	3913	1027	4207	1321	4620	1623	5384	1925	6148
30	1500	757	4026	1062	4331	1367	4758	1679	5548	1992	6339
31	1550	782	4140	1097	4455	1412	4895	1735	5712	2058	6530
32	1600	808	4253	1133	4578	1458	5033	1791	5877	2124	6720
33	1650	833	4367	1168	4702	1503	5171	1847	6041	2191	6911
34	1700	858	4480	1204	4826	1549	5309	1903	6205	2257	7102
35	1750	883	4594	1239	4950	1595	5447	1959	6370	2324	7292
36	1800	909	4708	1274	5073	1640	5585	2015	6534	2390	7483
37	1850	934	4821	1310	5197	1686	5723	2071	6698	2456	7674
38	1900	959	4935	1345	5321	1731	5861	2127	6862	2523	7864
39	1950	984	5048	1381	5444	1777	5999	2183	7027	2589	8055
40	2000	1010	5162	1416	5568	1822	6137	2239	7191	2656	8246
41	2050	1035	5275	1451	5692	1868	6275	2295	7355	2722	8436
42	2100	1060	5389	1487	5816	1914	6413	2351	7520	2788	8627
43	2150	1085	5503	1522	5939	1959	6551	2407	7684	2855	8818
44	2200	1111	5616	1558	6063	2005	6689	2463	7848	2921	9008
45	2250	1136	5730	1593	6187	2050	6827	2519	8013	2988	9199
46	2300	1161	5843	1628	6311	2096	6965	2575	8177	3054	9390
47	2350	1186	5957	1664	6434	2141	7103	2631	8341	3120	9580
48	2400	1212	6070	1699	6558	2187	7241	2687	8505	3187	9771
49	2450	1237	6184	1735	6682	2232	7379	2743	8670	3253	9962
50	2500	1262	6298	1770	6806	2278	7517	2799	8834	3320	10153

Grzejnik zaworowy

42 LASERLINE STANDARD ZAWOROWY

Ceny i wydajność cieplna

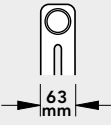
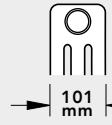
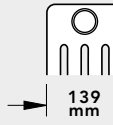
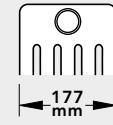
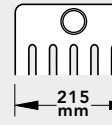
Product Class D13000 Item Group OOD90C ETIM Class EC003539

dane techniczne / ceny netto													
Ceny nie zawierają zamocowań. Niebieskie ceny dostawa możliwa w jednym bloku.													
 wysokość [mm]	2-kolumnowy		3-kolumnowy		4-kolumnowy		5-kolumnowy		6-kolumnowy				
	 rozstaw króćców 285 mm	 63 mm	 101 mm	 139 mm	 177 mm	 215 mm							
typ	2035		3035		4035		5035		6035				
wykładnik n	1,2269		1,2330		1,2390		1,2488		1,2585				
poj. wody/człon w l	0,44		0,64		0,84		1,03		1,23				
waga/człon w kg	0,60		0,89		1,20		1,49		1,86				
człony	 długość [mm]	[W]		PLN		[W]		PLN		[W]		PLN	
		4	200	116	1081	162	1122	208	1187	256	1292	304	1406
5	250	145	1197	203	1248	260	1329	320	1461	380	1603		
6	300	174	1313	243	1374	312	1471	384	1629	456	1800		
7	350	203	1428	284	1499	364	1613	448	1797	532	1996		
8	400	232	1544	324	1625	416	1755	512	1966	607	2193		
9	450	261	1660	365	1751	468	1897	576	2134	683	2390		
10	500	290	1775	405	1877	520	2039	640	2303	759	2587		
11	550	319	1891	446	2002	572	2181	704	2471	835	2783		
12	600	348	2006	486	2128	624	2323	768	2639	911	2980		
13	650	376	2122	527	2254	677	2465	832	2808	987	3177		
14	700	405	2238	567	2380	729	2607	896	2976	1063	3374		
15	750	434	2353	608	2505	781	2749	960	3144	1139	3570		
16	800	463	2469	648	2631	833	2891	1024	3313	1215	3767		
17	850	492	2585	689	2757	885	3033	1088	3481	1291	3964		
18	900	521	2700	729	2883	937	3175	1152	3649	1367	4161		
19	950	550	2816	770	3008	989	3317	1216	3818	1443	4357		
20	1000	579	2931	810	3134	1041	3459	1280	3986	1519	4554		
21	1050	608	3047	851	3260	1093	3601	1344	4154	1595	4751		
22	1100	637	3163	891	3386	1145	3743	1408	4323	1670	4948		
23	1150	666	3278	932	3511	1197	3885	1472	4491	1746	5144		
24	1200	695	3394	972	3637	1249	4027	1536	4659	1822	5341		
25	1250	724	3510	1013	3763	1301	4169	1600	4828	1898	5538		
26	1300	753	3625	1053	3889	1353	4311	1664	4996	1974	5735		
27	1350	782	3741	1094	4015	1405	4453	1728	5164	2050	5932		
28	1400	811	3856	1134	4140	1457	4595	1792	5333	2126	6128		
29	1450	840	3972	1175	4266	1509	4737	1856	5501	2202	6325		
30	1500	869	4088	1215	4392	1561	4879	1920	5670	2278	6522		
31	1550	898	4203	1256	4518	1613	5021	1984	5838	2354	6719		
32	1600	927	4319	1296	4643	1665	5163	2048	6006	2430	6915		
33	1650	956	4434	1337	4769	1717	5305	2112	6175	2506	7112		
34	1700	985	4550	1377	4895	1769	5447	2176	6343	2582	7309		
35	1750	1014	4666	1418	5021	1821	5589	2240	6511	2658	7506		
36	1800	1043	4781	1458	5146	1873	5731	2304	6680	2733	7702		
37	1850	1072	4897	1499	5272	1925	5873	2368	6848	2809	7899		
38	1900	1100	5013	1539	5398	1978	6015	2432	7016	2885	8096		
39	1950	1129	5128	1580	5524	2030	6157	2496	7185	2961	8293		
40	2000	1158	5244	1620	5649	2082	6299	2560	7353	3037	8489		
41	2050	1187	5359	1661	5775	2134	6441	2624	7521	3113	8686		
42	2100	1216	5475	1701	5901	2186	6583	2688	7690	3189	8883		
43	2150	1245	5591	1742	6027	2238	6725	2752	7858	3265	9080		
44	2200	1274	5706	1782	6152	2290	6867	2816	8026	3341	9276		
45	2250	1303	5822	1823	6278	2342	7009	2880	8195	3417	9473		
46	2300	1332	5938	1863	6404	2394	7151	2944	8363	3493	9670		
47	2350	1361	6053	1904	6530	2446	7293	3008	8531	3569	9867		
48	2400	1390	6169	1944	6655	2498	7435	3072	8700	3645	10063		
49	2450	1419	6284	1985	6781	2550	7577	3136	8868	3721	10260		
50	2500	1448	6400	2025	6907	2602	7720	3200	9037	3797	10457		

Moc cieplna grzejników [W] wg normy EN 442 dla parametrów 75/65/20 °C. PKWiU 25.21.11.0; CN 2020 7322 1900. Ceny netto w zł bez podatku VAT.

Product Class
D13000Item Group
00D90CETIM Class
ECO03539

dane techniczne / ceny netto

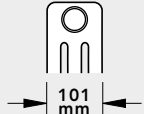
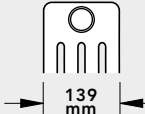
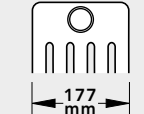
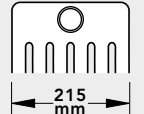

Ceny nie zawierają zamocowań. **Niebieskie ceny:** dostawa możliwa w jednym bloku.

wysokość [mm]				3-kolumnowy		4-kolumnowy		5-kolumnowy		6-kolumnowy	
365											
rozstaw króćców 300 mm				101 mm		139 mm		177 mm		215 mm	
typ				3037		4037		5037		6037	
wyktadnik n				1,2347		1,2417		1,2510		1,2603	
poj. wody/człon w l				0,66		0,86		1,06		1,27	
waga/człon w kg				0,91		1,22		1,54		1,86	
człony	długość [mm]	[W]	PLN	[W]	PLN	[W]	PLN	[W]	PLN	[W]	PLN
		4	200			168	1130	216	1195	265	1301
5	250			210	1258	270	1339	332	1471	394	1613
6	300			252	1386	324	1483	398	1641	473	1812
7	350			294	1514	378	1627	465	1812	551	2011
8	400			336	1641	432	1771	531	1982	630	2209
9	450			378	1769	486	1915	597	2152	709	2408
10	500			420	1897	540	2059	664	2323	788	2607
11	550			462	2025	594	2203	730	2493	866	2806
12	600			504	2152	648	2347	796	2664	945	3004
13	650			546	2280	701	2491	863	2834	1024	3203
14	700			588	2408	755	2635	929	3004	1103	3402
15	750			630	2536	809	2779	995	3175	1181	3601
16	800			672	2664	863	2923	1062	3345	1260	3800
17	850			714	2791	917	3067	1128	3515	1339	3998
18	900			756	2919	971	3211	1194	3686	1418	4197
19	950			798	3047	1025	3355	1261	3856	1496	4396
20	1000			840	3175	1079	3499	1327	4027	1575	4595
21	1050			882	3303	1133	3643	1394	4197	1654	4794
22	1100			924	3430	1187	3787	1460	4367	1733	4992
23	1150			966	3558	1241	3931	1526	4538	1811	5191
24	1200			1008	3686	1295	4075	1593	4708	1890	5390
25	1250			1050	3814	1349	4219	1659	4879	1969	5589
26	1300			1092	3942	1403	4363	1725	5049	2048	5788
27	1350			1134	4069	1457	4507	1792	5219	2127	5986
28	1400			1176	4197	1511	4651	1858	5390	2205	6185
29	1450			1218	4325	1565	4795	1924	5560	2284	6384
30	1500			1260	4453	1619	4939	1991	5730	2363	6583
31	1550			1302	4580	1673	5083	2057	5901	2442	6781
32	1600			1344	4708	1727	5227	2124	6071	2520	6980
33	1650			1386	4836	1781	5371	2190	6242	2599	7179
34	1700			1428	4964	1835	5515	2256	6412	2678	7378
35	1750			1470	5092	1889	5659	2323	6582	2757	7577
36	1800			1512	5219	1943	5803	2389	6753	2835	7775
37	1850			1554	5347	1997	5947	2455	6923	2914	7974
38	1900			1596	5475	2050	6091	2522	7093	2993	8173
39	1950			1638	5603	2104	6235	2588	7264	3072	8372
40	2000			1680	5731	2158	6379	2654	7434	3150	8571
41	2050			1722	5858	2212	6523	2721	7605	3229	8769
42	2100			1764	5986	2266	6667	2787	7775	3308	8968
43	2150			1806	6114	2320	6811	2853	7945	3387	9167
44	2200			1848	6242	2374	6955	2920	8116	3465	9366
45	2250			1890	6370	2428	7099	2986	8286	3544	9565
46	2300			1932	6497	2482	7243	3053	8456	3623	9763
47	2350			1974	6625	2536	7387	3119	8627	3702	9962
48	2400			2016	6753	2590	7531	3185	8797	3780	10161
49	2450			2058	6881	2644	7675	3252	8968	3859	10360
50	2500			2101	7009	2698	7820	3318	9138	3938	10559

44 LASERLINE STANDARD ZAWOROWY

Ceny i wydajność cieplna

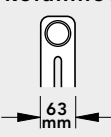
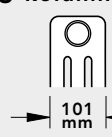
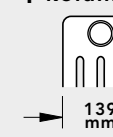
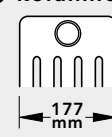
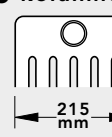
Product Class D13000 Item Group OOD90C ETIM Class EC003539

dane techniczne / ceny netto												
Ceny nie zawierają zamocowań. Niebieskie ceny dostawa możliwa w jednym bloku.												
wysokość [mm] 400	2-kolumnowy		3-kolumnowy		4-kolumnowy		5-kolumnowy		6-kolumnowy			
	 63 mm		 101 mm		 139 mm		 177 mm		 215 mm			
rozstaw króćców 335 mm	2040		3040		4040		5040		6040			
typ	1,2296		1,2388		1,2479		1,2562		1,2645			
wykładnik n	0,49		0,70		0,92		1,14		1,35			
poj. wody/człon w l	0,68		1,00		1,35		1,67		2,02			
waga/człon w kg	człony	 długość [mm]	[W]		[W]		[W]		[W]		[W]	
			PLN	PLN	PLN	PLN	PLN	PLN	PLN	PLN	PLN	
4	200	131	1090	182	1138	234	1203	287	1301	341	1438	
5	250	163	1207	228	1268	292	1349	359	1471	427	1643	
6	300	196	1325	273	1398	350	1495	431	1641	512	1848	
7	350	228	1443	319	1528	409	1641	503	1812	597	2053	
8	400	261	1560	364	1658	467	1787	575	1982	683	2258	
9	450	294	1678	410	1787	526	1933	647	2152	768	2463	
10	500	326	1796	455	1917	584	2080	719	2323	853	2668	
11	550	359	1913	501	2047	642	2226	791	2493	939	2873	
12	600	392	2031	546	2177	701	2372	862	2664	1024	3077	
13	650	424	2148	592	2307	759	2518	934	2834	1109	3282	
14	700	457	2266	637	2436	818	2664	1006	3004	1195	3487	
15	750	489	2384	683	2566	876	2810	1078	3175	1280	3692	
16	800	522	2501	728	2696	934	2956	1150	3345	1365	3897	
17	850	555	2619	774	2826	993	3102	1222	3515	1451	4102	
18	900	587	2737	819	2956	1051	3248	1294	3686	1536	4307	
19	950	620	2854	865	3086	1110	3394	1366	3856	1621	4512	
20	1000	653	2972	910	3215	1168	3540	1437	4027	1707	4716	
21	1050	685	3090	956	3345	1226	3686	1509	4197	1792	4921	
22	1100	718	3207	1001	3475	1285	3832	1581	4367	1877	5126	
23	1150	750	3325	1047	3605	1343	3978	1653	4538	1963	5331	
24	1200	783	3443	1092	3735	1402	4124	1725	4708	2048	5536	
25	1250	816	3560	1138	3865	1460	4270	1797	4879	2133	5741	
26	1300	848	3678	1184	3994	1518	4416	1869	5049	2219	5946	
27	1350	881	3796	1229	4124	1577	4562	1940	5219	2304	6150	
28	1400	914	3913	1275	4254	1635	4708	2012	5390	2389	6355	
29	1450	946	4031	1320	4384	1694	4854	2084	5560	2475	6560	
30	1500	979	4149	1366	4514	1752	5001	2156	5730	2560	6765	
31	1550	1012	4266	1411	4643	1810	5147	2228	5901	2645	6970	
32	1600	1044	4384	1457	4773	1869	5293	2300	6071	2731	7175	
33	1650	1077	4501	1502	4903	1927	5439	2372	6242	2816	7380	
34	1700	1109	4619	1548	5033	1986	5585	2444	6412	2901	7585	
35	1750	1142	4737	1593	5163	2044	5731	2515	6582	2987	7789	
36	1800	1175	4854	1639	5293	2102	5877	2587	6753	3072	7994	
37	1850	1207	4972	1684	5422	2161	6023	2659	6923	3157	8199	
38	1900	1240	5090	1730	5552	2219	6169	2731	7093	3243	8404	
39	1950	1273	5207	1775	5682	2278	6315	2803	7264	3328	8609	
40	2000	1305	5325	1821	5812	2336	6461	2875	7434	3413	8814	
41	2050	1338	5443	1866	5942	2394	6607	2947	7605	3499	9019	
42	2100	1370	5560	1912	6071	2453	6753	3019	7775	3584	9224	
43	2150	1403	5678	1957	6201	2511	6899	3090	7945	3669	9428	
44	2200	1436	5796	2003	6331	2570	7045	3162	8116	3755	9633	
45	2250	1468	5913	2048	6461	2628	7191	3234	8286	3840	9838	
46	2300	1501	6031	2094	6591	2686	7337	3306	8456	3925	10043	
47	2350	1534	6149	2139	6721	2745	7483	3378	8627	4011	10248	
48	2400	1566	6266	2185	6850	2803	7629	3450	8797	4096	10453	
49	2450	1599	6384	2230	6980	2862	7775	3522	8968	4181	10658	
50	2500	1632	6502	2276	7110	2920	7922	3594	9138	4267	10863	

Moc cieplna grzejników [W] wg normy EN 442 dla parametrów 75/65/20 °C. PKWiU 25.21.11.0; CN 2020 7322 1900. Ceny netto w zł bez podatku VAT.

Product Class
D13000

Item Group
00D90C

ETIM Class
ECO03539

dane techniczne / ceny netto

Ceny nie zawierają zamocowań. **Niebieskie ceny:** dostawa możliwa w jednym bloku.

wysokość [mm]				3-kolumnowy		4-kolumnowy				6-kolumnowy	
415				101 mm		139 mm				215 mm	
rozstaw króćców 350 mm											
typ				3042		4042				6042	
wyktadnik n				1,2405		1,2505				1,2663	
poj. wody/człon w l				0,72		0,95				1,39	
waga/człon w kg				1,03		1,37				2,08	
człony	dtu- gość [mm]	[W]	PLN	[W]	PLN	[W]	PLN	[W]	PLN	[W]	PLN
4	200			188	1146	241	1219			352	1438
5	250			235	1278	301	1369			441	1643
6	300			282	1410	362	1520			529	1848
7	350			329	1542	422	1670			617	2053
8	400			376	1674	482	1820			705	2258
9	450			423	1806	543	1970			793	2463
10	500			470	1938	603	2120			881	2668
11	550			517	2069	663	2270			969	2873
12	600			564	2201	723	2420			1057	3077
13	650			611	2333	784	2570			1146	3282
14	700			658	2465	844	2720			1234	3487
15	750			705	2597	904	2870			1322	3692
16	800			752	2729	965	3020			1410	3897
17	850			799	2860	1025	3171			1498	4102
18	900			846	2992	1085	3321			1586	4307
19	950			893	3124	1146	3471			1674	4512
20	1000			940	3256	1206	3621			1762	4716
21	1050			987	3388	1266	3771			1851	4921
22	1100			1034	3520	1326	3921			1939	5126
23	1150			1081	3652	1387	4071			2027	5331
24	1200			1128	3783	1447	4221			2115	5536
25	1250			1175	3915	1507	4371			2203	5741
26	1300			1222	4047	1568	4521			2291	5946
27	1350			1269	4179	1628	4671			2379	6150
28	1400			1316	4311	1688	4822			2467	6355
29	1450			1363	4443	1748	4972			2555	6560
30	1500			1410	4575	1809	5122			2644	6765
31	1550			1457	4706	1869	5272			2732	6970
32	1600			1504	4838	1929	5422			2820	7175
33	1650			1551	4970	1990	5572			2908	7380
34	1700			1598	5102	2050	5722			2996	7585
35	1750			1645	5234	2110	5872			3084	7789
36	1800			1692	5366	2170	6022			3172	7994
37	1850			1739	5497	2231	6172			3260	8199
38	1900			1786	5629	2291	6322			3349	8404
39	1950			1833	5761	2351	6473			3437	8609
40	2000			1880	5893	2412	6623			3525	8814
41	2050			1927	6025	2472	6773			3613	9019
42	2100			1974	6157	2532	6923			3701	9224
43	2150			2021	6289	2592	7073			3789	9428
44	2200			2068	6420	2653	7223			3877	9633
45	2250			2115	6552	2713	7373			3965	9838
46	2300			2162	6684	2773	7523			4054	10043
47	2350			2209	6816	2834	7673			4142	10248
48	2400			2256	6948	2894	7823			4230	10453
49	2450			2303	7080	2954	7973			4318	10658
50	2500			2351	7212	3015	8124			4406	10863

Grzejnik zaworowy

dane techniczne / ceny netto

Ceny nie zawierają zamocowań. **Niebieskie ceny**: dostawa możliwa w jednym bloku.

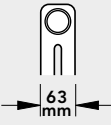
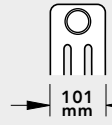
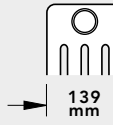
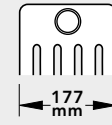
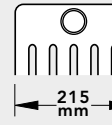
wysokość [mm] 450		2-kolumnowy		3-kolumnowy		4-kolumnowy		5-kolumnowy		6-kolumnowy	
rozstaw króćców 385 mm											
typ		2045		3045		4045		5045		6045	
wykładnik n		1,2325		1,2445		1,2564		1,2634		1,2703	
poj. wody/człon w l		0,53		0,76		1,01		1,24		1,48	
waga/człon w kg		0,75		1,12		1,49		1,86		2,24	
człony	długość [mm]	[W]		[W]		[W]		[W]		[W]	
			PLN		PLN		PLN		PLN		PLN
4	200	145	1106	202	1163	259	1227	319	1333	378	1447
5	250	181	1227	252	1298	323	1380	398	1512	473	1654
6	300	218	1349	303	1434	388	1532	478	1690	568	1860
7	350	254	1471	353	1570	453	1684	557	1869	662	2067
8	400	290	1593	404	1706	517	1836	637	2047	757	2274
9	450	326	1714	454	1842	582	1988	717	2226	851	2481
10	500	363	1836	505	1978	647	2140	796	2404	946	2688
11	550	399	1958	555	2114	711	2292	876	2583	1041	2895
12	600	435	2079	606	2250	776	2444	956	2761	1135	3102
13	650	471	2201	656	2386	841	2597	1035	2940	1230	3309
14	700	508	2323	707	2521	906	2749	1115	3118	1324	3516
15	750	544	2444	757	2657	970	2901	1195	3297	1419	3723
16	800	580	2566	808	2793	1035	3053	1274	3475	1514	3929
17	850	616	2688	858	2929	1100	3205	1354	3654	1608	4136
18	900	653	2809	908	3065	1164	3357	1434	3832	1703	4343
19	950	689	2931	959	3201	1229	3509	1513	4011	1797	4550
20	1000	725	3053	1009	3337	1294	3661	1593	4189	1892	4757
21	1050	761	3174	1060	3473	1358	3814	1672	4368	1987	4964
22	1100	798	3296	1110	3609	1423	3966	1752	4546	2081	5171
23	1150	834	3418	1161	3744	1488	4118	1832	4725	2176	5378
24	1200	870	3540	1211	3880	1552	4270	1911	4903	2270	5585
25	1250	907	3661	1262	4016	1617	4422	1991	5082	2365	5792
26	1300	943	3783	1312	4152	1682	4574	2071	5260	2460	5998
27	1350	979	3905	1363	4288	1746	4726	2150	5439	2554	6205
28	1400	1015	4026	1413	4424	1811	4878	2230	5617	2649	6412
29	1450	1052	4148	1464	4560	1876	5030	2310	5796	2743	6619
30	1500	1088	4270	1514	4696	1940	5183	2389	5974	2838	6826
31	1550	1124	4391	1565	4832	2005	5335	2469	6153	2933	7033
32	1600	1160	4513	1615	4967	2070	5487	2548	6331	3027	7240
33	1650	1197	4635	1666	5103	2134	5639	2628	6510	3122	7447
34	1700	1233	4756	1716	5239	2199	5791	2708	6688	3216	7654
35	1750	1269	4878	1766	5375	2264	5943	2787	6867	3311	7861
36	1800	1305	5000	1817	5511	2328	6095	2867	7045	3406	8067
37	1850	1342	5122	1867	5647	2393	6247	2947	7224	3500	8274
38	1900	1378	5243	1918	5783	2458	6400	3026	7402	3595	8481
39	1950	1414	5365	1968	5919	2523	6552	3106	7581	3689	8688
40	2000	1450	5487	2019	6055	2587	6704	3186	7759	3784	8895
41	2050	1487	5608	2069	6190	2652	6856	3265	7938	3879	9102
42	2100	1523	5730	2120	6326	2717	7008	3345	8116	3973	9309
43	2150	1559	5852	2170	6462	2781	7160	3425	8295	4068	9516
44	2200	1595	5973	2221	6598	2846	7312	3504	8473	4162	9723
45	2250	1632	6095	2271	6734	2911	7464	3584	8652	4257	9930
46	2300	1668	6217	2322	6870	2975	7617	3663	8830	4352	10136
47	2350	1704	6338	2372	7006	3040	7769	3743	9009	4446	10343
48	2400	1740	6460	2423	7142	3105	7921	3823	9187	4541	10550
49	2450	1777	6582	2473	7278	3169	8073	3902	9366	4635	10757
50	2500	1813	6704	2524	7414	3234	8225	3982	9544	4730	10964

Product Class D13000 Item Group OOD90C ETIM Class ECO03539

dane techniczne / ceny netto

Ceny nie zawierają zamocowań. **Niebieskie ceny:** dostawa możliwa w jednym bloku.

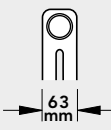
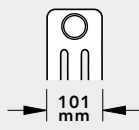
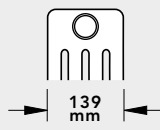
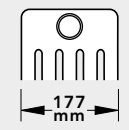
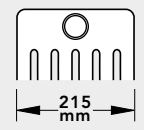
wysokość [mm]		2-kolumnowy		3-kolumnowy		4-kolumnowy		5-kolumnowy		6-kolumnowy	
500											
rozstaw króćców 435 mm											
typ		2050		3050		4050		5050		6050	
wyktadnik n		1,2354		1,2499		1,2644		1,2702		1,2759	
poj. wody/człon w l		0,57		0,83		1,09		1,34		1,60	
waga/człon w kg		0,83		1,23		1,64		2,04		2,46	
człony	długość [mm]	[W]		[W]		[W]		[W]		[W]	
			PLN		PLN		PLN		PLN		PLN
4	200	159	1114	222	1187	284	1244	349	1349	415	1471
5	250	199	1238	277	1329	354	1400	437	1532	519	1684
6	300	239	1361	332	1471	425	1556	524	1715	623	1897
7	350	279	1485	388	1613	496	1712	611	1897	726	2110
8	400	319	1609	443	1755	567	1869	699	2080	830	2323
9	450	359	1733	498	1897	638	2025	786	2262	934	2536
10	500	399	1856	554	2039	709	2181	873	2445	1038	2749
11	550	439	1980	609	2181	780	2337	961	2627	1141	2962
12	600	478	2104	665	2323	851	2494	1048	2810	1245	3175
13	650	518	2227	720	2465	921	2650	1135	2993	1349	3388
14	700	558	2351	775	2607	992	2806	1222	3175	1453	3601
15	750	598	2475	831	2749	1063	2962	1310	3358	1556	3814
16	800	638	2599	886	2891	1134	3118	1397	3540	1660	4027
17	850	678	2722	941	3033	1205	3275	1484	3723	1764	4240
18	900	718	2846	997	3175	1276	3431	1572	3906	1868	4453
19	950	758	2970	1052	3317	1347	3587	1659	4088	1971	4666
20	1000	797	3094	1108	3459	1418	3743	1746	4271	2075	4879
21	1050	837	3217	1163	3601	1488	3899	1834	4453	2179	5092
22	1100	877	3341	1218	3743	1559	4056	1921	4636	2283	5305
23	1150	917	3465	1274	3885	1630	4212	2008	4819	2386	5518
24	1200	957	3589	1329	4027	1701	4368	2096	5001	2490	5731
25	1250	997	3712	1385	4169	1772	4524	2183	5184	2594	5944
26	1300	1037	3836	1440	4311	1843	4680	2270	5366	2698	6156
27	1350	1076	3960	1495	4453	1914	4837	2358	5549	2802	6369
28	1400	1116	4083	1551	4595	1985	4993	2445	5732	2905	6582
29	1450	1156	4207	1606	4737	2056	5149	2532	5914	3009	6795
30	1500	1196	4331	1661	4879	2126	5305	2620	6097	3113	7008
31	1550	1236	4455	1717	5021	2197	5462	2707	6279	3217	7221
32	1600	1276	4578	1772	5163	2268	5618	2794	6462	3320	7434
33	1650	1316	4702	1828	5305	2339	5774	2882	6644	3424	7647
34	1700	1356	4826	1883	5447	2410	5930	2969	6827	3528	7860
35	1750	1395	4950	1938	5589	2481	6086	3056	7010	3632	8073
36	1800	1435	5073	1994	5731	2552	6243	3144	7192	3735	8286
37	1850	1475	5197	2049	5873	2623	6399	3231	7375	3839	8499
38	1900	1515	5321	2104	6015	2693	6555	3318	7557	3943	8712
39	1950	1555	5444	2160	6157	2764	6711	3405	7740	4047	8925
40	2000	1595	5568	2215	6299	2835	6867	3493	7923	4150	9138
41	2050	1635	5692	2271	6441	2906	7024	3580	8105	4254	9351
42	2100	1675	5816	2326	6583	2977	7180	3667	8288	4358	9564
43	2150	1714	5939	2381	6725	3048	7336	3755	8470	4462	9777
44	2200	1754	6063	2437	6867	3119	7492	3842	8653	4565	9990
45	2250	1794	6187	2492	7009	3190	7648	3929	8836	4669	10203
46	2300	1834	6311	2547	7151	3260	7805	4017	9018	4773	10416
47	2350	1874	6434	2603	7293	3331	7961	4104	9201	4877	10629
48	2400	1914	6558	2658	7435	3402	8117	4191	9383	4980	10842
49	2450	1954	6682	2714	7577	3473	8273	4279	9566	5084	11055
50	2500	1994	6806	2769	7720	3544	8430	4366	9749	5188	11268

Grzejnik zaworowy

dane techniczne / ceny netto

Ceny nie zawierają zamocowań. **Niebieskie ceny**: dostawa możliwa w jednym bloku.

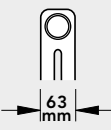
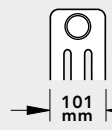
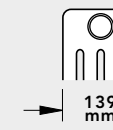
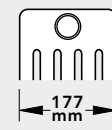
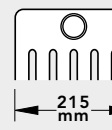
wysokość [mm]		2-kolumnowy		3-kolumnowy		4-kolumnowy		5-kolumnowy		6-kolumnowy	
550											
rozstaw króćców 485 mm											
typ		2055		3055		4055		5055		6055	
wykładnik n		1,2384		1,2552		1,2720		1,2767		1,2813	
poj. wody/człon w l		0,62		0,89		1,17		1,45		1,73	
waga/człon w kg		0,91		1,34		1,79		2,23		2,68	
człony	długość [mm]	[W]		[W]		[W]		[W]		[W]	
			PLN		PLN		PLN		PLN		PLN
4	200	174	1130	241	1195	308	1260	380	1374	451	1512
5	250	217	1258	301	1339	385	1420	475	1562	564	1735
6	300	261	1386	362	1483	462	1581	570	1751	677	1958
7	350	304	1514	422	1627	539	1741	665	1940	790	2181
8	400	348	1641	482	1771	616	1901	759	2128	903	2404
9	450	391	1769	542	1915	693	2061	854	2317	1015	2627
10	500	435	1897	603	2059	770	2222	949	2506	1128	2850
11	550	478	2025	663	2203	847	2382	1044	2694	1241	3073
12	600	522	2152	723	2347	924	2542	1139	2883	1354	3297
13	650	565	2280	783	2491	1001	2702	1234	3071	1467	3520
14	700	608	2408	844	2635	1078	2863	1329	3260	1580	3743
15	750	652	2536	904	2779	1155	3023	1424	3449	1692	3966
16	800	695	2664	964	2923	1232	3183	1519	3637	1805	4189
17	850	739	2791	1024	3067	1310	3343	1614	3826	1918	4412
18	900	782	2919	1085	3211	1387	3504	1709	4015	2031	4635
19	950	826	3047	1145	3355	1464	3664	1804	4203	2144	4858
20	1000	869	3175	1205	3499	1541	3824	1899	4392	2257	5082
21	1050	913	3303	1265	3643	1618	3984	1994	4581	2369	5305
22	1100	956	3430	1326	3787	1695	4145	2088	4769	2482	5528
23	1150	1000	3558	1386	3931	1772	4305	2183	4958	2595	5751
24	1200	1043	3686	1446	4075	1849	4465	2278	5147	2708	5974
25	1250	1087	3814	1506	4219	1926	4626	2373	5335	2821	6197
26	1300	1130	3942	1567	4363	2003	4786	2468	5524	2934	6420
27	1350	1173	4069	1627	4507	2080	4946	2563	5713	3046	6644
28	1400	1217	4197	1687	4651	2157	5106	2658	5901	3159	6867
29	1450	1260	4325	1747	4795	2234	5267	2753	6090	3272	7090
30	1500	1304	4453	1808	4939	2311	5427	2848	6279	3385	7313
31	1550	1347	4580	1868	5083	2388	5587	2943	6467	3498	7536
32	1600	1391	4708	1928	5227	2465	5747	3038	6656	3611	7759
33	1650	1434	4836	1988	5371	2542	5908	3133	6844	3723	7982
34	1700	1478	4964	2049	5515	2619	6068	3228	7033	3836	8205
35	1750	1521	5092	2109	5659	2696	6228	3323	7222	3949	8429
36	1800	1565	5219	2169	5803	2773	6388	3417	7410	4062	8652
37	1850	1608	5347	2229	5947	2850	6549	3512	7599	4175	8875
38	1900	1651	5475	2290	6091	2927	6709	3607	7788	4288	9098
39	1950	1695	5603	2350	6235	3004	6869	3702	7976	4400	9321
40	2000	1738	5731	2410	6379	3081	7029	3797	8165	4513	9544
41	2050	1782	5858	2470	6523	3158	7190	3892	8354	4626	9767
42	2100	1825	5986	2531	6667	3235	7350	3987	8542	4739	9990
43	2150	1869	6114	2591	6811	3312	7510	4082	8731	4852	10214
44	2200	1912	6242	2651	6955	3389	7670	4177	8920	4965	10437
45	2250	1956	6370	2711	7099	3466	7831	4272	9108	5077	10660
46	2300	1999	6497	2772	7243	3543	7991	4367	9297	5190	10883
47	2350	2043	6625	2832	7387	3620	8151	4462	9486	5303	11106
48	2400	2086	6753	2892	7531	3697	8311	4557	9674	5416	11329
49	2450	2130	6881	2952	7675	3774	8472	4652	9863	5529	11552
50	2500	2173	7009	3013	7820	3852	8632	4747	10052	5642	11776

Product Class D13000 Item Group OOD90C ETIM Class ECO03539

dane techniczne / ceny netto

Ceny nie zawierają zamocowań. **Niebieskie ceny**: dostawa możliwa w jednym bloku.

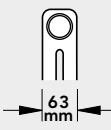
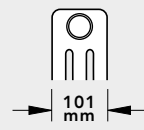
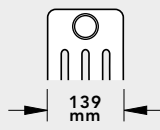
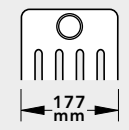
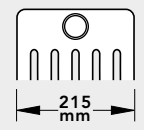
wysokość [mm]		2-kolumnowy		3-kolumnowy		4-kolumnowy		5-kolumnowy		6-kolumnowy	
565											
rozstaw króćców 500 mm											
typ		2057		3057		4057		5057		6057	
wyktadnik n		1,2393		1,2568		1,2742		1,2786		1,2829	
poj. wody/człon w l		0,63		0,91		1,20		1,48		1,76	
waga/człon w kg		0,93		1,38		1,84		2,29		2,75	
człony	długość [mm]	[W]		[W]		[W]		[W]		[W]	
			PLN		PLN		PLN		PLN		PLN
4	200	178	1130	247	1203	315	1284	389	1398	462	1544
5	250	223	1258	309	1349	394	1451	486	1593	578	1775
6	300	267	1386	370	1495	473	1617	583	1787	693	2006
7	350	312	1514	432	1641	552	1783	680	1982	809	2238
8	400	356	1641	494	1787	631	1949	778	2177	924	2469
9	450	401	1769	555	1933	710	2116	875	2371	1040	2700
10	500	445	1897	617	2080	789	2282	972	2566	1155	2931
11	550	490	2025	679	2226	867	2448	1069	2761	1271	3163
12	600	534	2152	740	2372	946	2615	1166	2956	1386	3394
13	650	579	2280	802	2518	1025	2781	1264	3150	1502	3625
14	700	623	2408	864	2664	1104	2947	1361	3345	1618	3856
15	750	668	2536	926	2810	1183	3114	1458	3540	1733	4088
16	800	712	2664	987	2956	1262	3280	1555	3735	1849	4319
17	850	757	2791	1049	3102	1341	3446	1652	3929	1964	4550
18	900	802	2919	1111	3248	1419	3612	1750	4124	2080	4781
19	950	846	3047	1172	3394	1498	3779	1847	4319	2195	5013
20	1000	891	3175	1234	3540	1577	3945	1944	4513	2311	5244
21	1050	935	3303	1296	3686	1656	4111	2041	4708	2426	5475
22	1100	980	3430	1357	3832	1735	4278	2138	4903	2542	5706
23	1150	1024	3558	1419	3978	1814	4444	2236	5098	2657	5938
24	1200	1069	3686	1481	4124	1893	4610	2333	5292	2773	6169
25	1250	1113	3814	1543	4270	1972	4777	2430	5487	2889	6400
26	1300	1158	3942	1604	4416	2050	4943	2527	5682	3004	6631
27	1350	1202	4069	1666	4562	2129	5109	2624	5876	3120	6862
28	1400	1247	4197	1728	4708	2208	5275	2722	6071	3235	7094
29	1450	1291	4325	1789	4854	2287	5442	2819	6266	3351	7325
30	1500	1336	4453	1851	5001	2366	5608	2916	6461	3466	7556
31	1550	1380	4580	1913	5147	2445	5774	3013	6655	3582	7787
32	1600	1425	4708	1974	5293	2524	5941	3110	6850	3697	8019
33	1650	1469	4836	2036	5439	2602	6107	3208	7045	3813	8250
34	1700	1514	4964	2098	5585	2681	6273	3305	7239	3928	8481
35	1750	1559	5092	2160	5731	2760	6440	3402	7434	4044	8712
36	1800	1603	5219	2221	5877	2839	6606	3499	7629	4159	8944
37	1850	1648	5347	2283	6023	2918	6772	3596	7824	4275	9175
38	1900	1692	5475	2345	6169	2997	6938	3694	8018	4391	9406
39	1950	1737	5603	2406	6315	3076	7105	3791	8213	4506	9637
40	2000	1781	5731	2468	6461	3154	7271	3888	8408	4622	9869
41	2050	1826	5858	2530	6607	3233	7437	3985	8603	4737	10100
42	2100	1870	5986	2591	6753	3312	7604	4082	8797	4853	10331
43	2150	1915	6114	2653	6899	3391	7770	4180	8992	4968	10562
44	2200	1959	6242	2715	7045	3470	7936	4277	9187	5084	10794
45	2250	2004	6370	2777	7191	3549	8103	4374	9381	5199	11025
46	2300	2048	6497	2838	7337	3628	8269	4471	9576	5315	11256
47	2350	2093	6625	2900	7483	3706	8435	4568	9771	5430	11487
48	2400	2137	6753	2962	7629	3785	8601	4666	9966	5546	11719
49	2450	2182	6881	3023	7775	3864	8768	4763	10160	5661	11950
50	2500	2227	7009	3085	7922	3943	8934	4860	10355	5777	12181

Grzejnik zaworowy

50 LASERLINE STANDARD ZAWOROWY

Ceny i wydajność cieplna

Product Class
D13000

Item Group
OOD90C

ETIM Class
EC003539

dane techniczne / ceny netto

Ceny nie zawierają zamocowań. **Niebieskie ceny**: dostawa możliwa w jednym bloku.

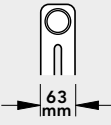
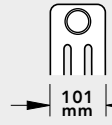
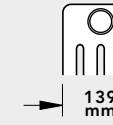
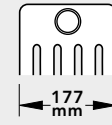
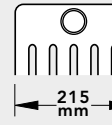
wysokość [mm] 600		2-kolumnowy		3-kolumnowy		4-kolumnowy		5-kolumnowy		6-kolumnowy	
rozstaw króćców 535 mm											
typ		2060		3060		4060		5060		6060	
wykładnik n		1,2415		1,2604		1,2793		1,2829		1,2865	
poj. wody/człon w l		0,66		0,96		1,26		1,55		1,85	
waga/człon w kg		0,98		1,46		1,94		2,42		2,91	
człony	długość [mm]	[W]		[W]		[W]		[W]		[W]	
		PLN	PLN	PLN	PLN	PLN	PLN	PLN	PLN	PLN	
4	200	188	1138	260	1211	332	1292	410	1406	487	1544
5	250	235	1268	325	1359	416	1461	512	1603	609	1775
6	300	282	1398	390	1507	499	1629	615	1800	731	2006
7	350	329	1528	455	1656	582	1797	717	1996	853	2238
8	400	376	1658	521	1804	665	1966	820	2193	975	2469
9	450	423	1787	586	1952	748	2134	922	2390	1096	2700
10	500	470	1917	651	2100	831	2303	1025	2587	1218	2931
11	550	517	2047	716	2248	914	2471	1127	2783	1340	3163
12	600	564	2177	781	2396	997	2639	1230	2980	1462	3394
13	650	611	2307	846	2544	1081	2808	1332	3177	1584	3625
14	700	658	2436	911	2692	1164	2976	1435	3374	1706	3856
15	750	705	2566	976	2840	1247	3144	1537	3570	1827	4088
16	800	752	2696	1041	2988	1330	3313	1640	3767	1949	4319
17	850	799	2826	1106	3136	1413	3481	1742	3964	2071	4550
18	900	846	2956	1171	3284	1496	3649	1845	4161	2193	4781
19	950	893	3086	1236	3433	1579	3818	1947	4357	2315	5013
20	1000	940	3215	1301	3581	1662	3986	2050	4554	2437	5244
21	1050	987	3345	1366	3729	1746	4154	2152	4751	2558	5475
22	1100	1034	3475	1432	3877	1829	4323	2255	4948	2680	5706
23	1150	1081	3605	1497	4025	1912	4491	2357	5144	2802	5938
24	1200	1128	3735	1562	4173	1995	4659	2460	5341	2924	6169
25	1250	1176	3865	1627	4321	2078	4828	2562	5538	3046	6400
26	1300	1223	3994	1692	4469	2161	4996	2664	5735	3168	6631
27	1350	1270	4124	1757	4617	2244	5164	2767	5932	3289	6862
28	1400	1317	4254	1822	4765	2327	5333	2869	6128	3411	7094
29	1450	1364	4384	1887	4913	2410	5501	2972	6325	3533	7325
30	1500	1411	4514	1952	5061	2494	5670	3074	6522	3655	7556
31	1550	1458	4643	2017	5209	2577	5838	3177	6719	3777	7787
32	1600	1505	4773	2082	5358	2660	6006	3279	6915	3899	8019
33	1650	1552	4903	2147	5506	2743	6175	3382	7112	4020	8250
34	1700	1599	5033	2212	5654	2826	6343	3484	7309	4142	8481
35	1750	1646	5163	2277	5802	2909	6511	3587	7506	4264	8712
36	1800	1693	5293	2343	5950	2992	6680	3689	7702	4386	8944
37	1850	1740	5422	2408	6098	3075	6848	3792	7899	4508	9175
38	1900	1787	5552	2473	6246	3159	7016	3894	8096	4630	9406
39	1950	1834	5682	2538	6394	3242	7185	3997	8293	4751	9637
40	2000	1881	5812	2603	6542	3325	7353	4099	8489	4873	9869
41	2050	1928	5942	2668	6690	3408	7521	4202	8686	4995	10100
42	2100	1975	6071	2733	6838	3491	7690	4304	8883	5117	10331
43	2150	2022	6201	2798	6986	3574	7858	4407	9080	5239	10562
44	2200	2069	6331	2863	7135	3657	8026	4509	9276	5361	10794
45	2250	2116	6461	2928	7283	3740	8195	4612	9473	5482	11025
46	2300	2163	6591	2993	7431	3824	8363	4714	9670	5604	11256
47	2350	2210	6721	3058	7579	3907	8531	4817	9867	5726	11487
48	2400	2257	6850	3123	7727	3990	8700	4919	10063	5848	11719
49	2450	2304	6980	3188	7875	4073	8868	5022	10260	5970	11950
50	2500	2351	7110	3254	8023	4156	9037	5124	10457	6092	12181

Moc cieplna grzejników [W] wg normy EN 442 dla parametrów 75/65/20 °C. PKWiU 25.21.11.0; CN 2020 7322 1900. Ceny netto w zł bez podatku VAT.

Product Class D13000 Item Group 00D90C ETIM Class ECO03539

dane techniczne / ceny netto

Ceny nie zawierają zamocowań. **Niebieskie ceny**: dostawa możliwa w jednym bloku.

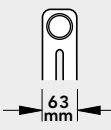
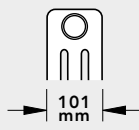
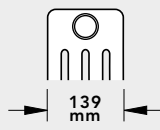
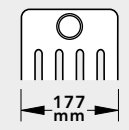
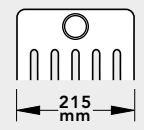
wysokość [mm]		2-kolumnowy		3-kolumnowy		4-kolumnowy		5-kolumnowy		6-kolumnowy	
665											
rozstaw króćców 600 mm											
typ		2067		3067		4067		5067		6067	
wyktadnik n		1,2457		1,2669		1,2881		1,2905		1,2929	
poj. wody/człon w l		0,72		1,04		1,37		1,69		2,01	
waga/człon w kg		1,08		1,60		2,14		2,66		3,20	
człony	długość [mm]	[W]		[W]		[W]		[W]		[W]	
			PLN		PLN		PLN		PLN		PLN
4	200	207	1155	285	1236	364	1374	449	1528	534	1649
5	250	258	1288	357	1390	455	1562	561	1755	667	1907
6	300	310	1422	428	1544	546	1751	673	1982	801	2165
7	350	361	1556	499	1698	637	1940	785	2209	934	2422
8	400	413	1690	570	1852	728	2128	898	2437	1067	2680
9	450	465	1824	642	2006	819	2317	1010	2664	1201	2937
10	500	516	1958	713	2160	910	2506	1122	2891	1334	3195
11	550	568	2092	784	2314	1001	2694	1234	3118	1468	3453
12	600	620	2226	856	2469	1092	2883	1346	3345	1601	3710
13	650	671	2359	927	2623	1183	3071	1459	3572	1734	3968
14	700	723	2493	998	2777	1274	3260	1571	3800	1868	4226
15	750	775	2627	1070	2931	1365	3449	1683	4027	2001	4483
16	800	826	2761	1141	3085	1456	3637	1795	4254	2135	4741
17	850	878	2895	1212	3239	1546	3826	1907	4481	2268	4998
18	900	930	3029	1284	3393	1637	4015	2020	4708	2402	5256
19	950	981	3163	1355	3547	1728	4203	2132	4936	2535	5514
20	1000	1033	3297	1426	3702	1819	4392	2244	5163	2668	5771
21	1050	1084	3430	1498	3856	1910	4581	2356	5390	2802	6029
22	1100	1136	3564	1569	4010	2001	4769	2468	5617	2935	6286
23	1150	1188	3698	1640	4164	2092	4958	2581	5844	3069	6544
24	1200	1239	3832	1711	4318	2183	5147	2693	6072	3202	6802
25	1250	1291	3966	1783	4472	2274	5335	2805	6299	3336	7059
26	1300	1343	4100	1854	4626	2365	5524	2917	6526	3469	7317
27	1350	1394	4234	1925	4781	2456	5713	3029	6753	3602	7574
28	1400	1446	4368	1997	4935	2547	5901	3142	6980	3736	7832
29	1450	1498	4502	2068	5089	2638	6090	3254	7208	3869	8090
30	1500	1549	4635	2139	5243	2729	6279	3366	7435	4003	8347
31	1550	1601	4769	2211	5397	2820	6467	3478	7662	4136	8605
32	1600	1652	4903	2282	5551	2911	6656	3590	7889	4269	8863
33	1650	1704	5037	2353	5705	3002	6844	3703	8116	4403	9120
34	1700	1756	5171	2425	5859	3093	7033	3815	8343	4536	9378
35	1750	1807	5305	2496	6014	3184	7222	3927	8571	4670	9635
36	1800	1859	5439	2567	6168	3275	7410	4039	8798	4803	9893
37	1850	1911	5573	2638	6322	3366	7599	4151	9025	4937	10151
38	1900	1962	5706	2710	6476	3457	7788	4264	9252	5070	10408
39	1950	2014	5840	2781	6630	3548	7976	4376	9479	5203	10666
40	2000	2066	5974	2852	6784	3639	8165	4488	9707	5337	10923
41	2050	2117	6108	2924	6938	3730	8354	4600	9934	5470	11181
42	2100	2169	6242	2995	7092	3821	8542	4712	10161	5604	11439
43	2150	2221	6376	3066	7247	3912	8731	4825	10388	5737	11696
44	2200	2272	6510	3138	7401	4003	8920	4937	10615	5870	11954
45	2250	2324	6644	3209	7555	4094	9108	5049	10843	6004	12211
46	2300	2375	6777	3280	7709	4185	9297	5161	11070	6137	12469
47	2350	2427	6911	3352	7863	4276	9486	5273	11297	6271	12727
48	2400	2479	7045	3423	8017	4367	9674	5386	11524	6404	12984
49	2450	2530	7179	3494	8171	4458	9863	5498	11751	6538	13242
50	2500	2582	7313	3566	8326	4549	10052	5610	11979	6671	13500

Grzejnik zaworowy

dane techniczne / ceny netto

Ceny nie zawierają zamocowań. **Niebieskie ceny**: dostawa możliwa w jednym bloku.

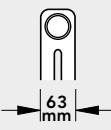
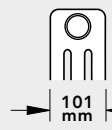
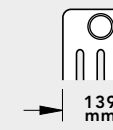
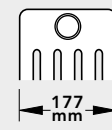
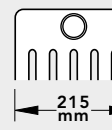
wysokość [mm] 750		2-kolumnowy		3-kolumnowy		4-kolumnowy		5-kolumnowy		6-kolumnowy	
rozstaw króćców 685 mm											
typ		2075		3075		4075		5075		6075	
wykładnik n		1,2513		1,2750		1,2986		1,2997		1,3008	
poj. wody/człon w l		0,80		1,15		1,51		1,86		2,22	
waga/człon w kg		1,21		1,79		2,39		2,97		3,58	
człony	długość [mm]	[W]		[W]		[W]		[W]		[W]	
		PLN	PLN	PLN	PLN	PLN	PLN	PLN	PLN	PLN	
4	200	231	1171	318	1252	405	1390	499	1528	594	1674
5	250	288	1309	397	1410	506	1583	624	1755	742	1938
6	300	346	1447	476	1568	607	1775	749	1982	891	2201
7	350	404	1585	556	1726	708	1968	874	2209	1039	2465
8	400	461	1723	635	1885	809	2161	998	2437	1188	2729
9	450	519	1861	715	2043	910	2353	1123	2664	1336	2992
10	500	577	1999	794	2201	1012	2546	1248	2891	1485	3256
11	550	634	2136	873	2359	1113	2739	1373	3118	1633	3520
12	600	692	2274	953	2518	1214	2931	1498	3345	1781	3783
13	650	749	2412	1032	2676	1315	3124	1622	3572	1930	4047
14	700	807	2550	1112	2834	1416	3317	1747	3800	2078	4311
15	750	865	2688	1191	2992	1517	3510	1872	4027	2227	4575
16	800	922	2826	1270	3150	1618	3702	1997	4254	2375	4838
17	850	980	2964	1350	3309	1720	3895	2122	4481	2524	5102
18	900	1038	3102	1429	3467	1821	4088	2246	4708	2672	5366
19	950	1095	3240	1509	3625	1922	4280	2371	4936	2821	5629
20	1000	1153	3378	1588	3783	2023	4473	2496	5163	2969	5893
21	1050	1211	3516	1667	3941	2124	4666	2621	5390	3117	6157
22	1100	1268	3654	1747	4100	2225	4858	2746	5617	3266	6420
23	1150	1326	3792	1826	4258	2326	5051	2870	5844	3414	6684
24	1200	1384	3930	1906	4416	2428	5244	2995	6072	3563	6948
25	1250	1441	4068	1985	4574	2529	5437	3120	6299	3711	7212
26	1300	1499	4206	2064	4732	2630	5629	3245	6526	3860	7475
27	1350	1557	4344	2144	4891	2731	5822	3370	6753	4008	7739
28	1400	1614	4482	2223	5049	2832	6015	3494	6980	4157	8003
29	1450	1672	4620	2303	5207	2933	6207	3619	7208	4305	8266
30	1500	1730	4758	2382	5365	3035	6400	3744	7435	4454	8530
31	1550	1787	4895	2461	5524	3136	6593	3869	7662	4602	8794
32	1600	1845	5033	2541	5682	3237	6785	3994	7889	4750	9057
33	1650	1902	5171	2620	5840	3338	6978	4118	8116	4899	9321
34	1700	1960	5309	2700	5998	3439	7171	4243	8343	5047	9585
35	1750	2018	5447	2779	6156	3540	7364	4368	8571	5196	9849
36	1800	2075	5585	2858	6315	3641	7556	4493	8798	5344	10112
37	1850	2133	5723	2938	6473	3743	7749	4618	9025	5493	10376
38	1900	2191	5861	3017	6631	3844	7942	4742	9252	5641	10640
39	1950	2248	5999	3097	6789	3945	8134	4867	9479	5790	10903
40	2000	2306	6137	3176	6947	4046	8327	4992	9707	5938	11167
41	2050	2364	6275	3255	7106	4147	8520	5117	9934	6086	11431
42	2100	2421	6413	3335	7264	4248	8712	5242	10161	6235	11694
43	2150	2479	6551	3414	7422	4349	8905	5366	10388	6383	11958
44	2200	2537	6689	3494	7580	4451	9098	5491	10615	6532	12222
45	2250	2594	6827	3573	7738	4552	9291	5616	10843	6680	12486
46	2300	2652	6965	3652	7897	4653	9483	5741	11070	6829	12749
47	2350	2710	7103	3732	8055	4754	9676	5866	11297	6977	13013
48	2400	2767	7241	3811	8213	4855	9869	5990	11524	7126	13277
49	2450	2825	7379	3891	8371	4956	10061	6115	11751	7274	13540
50	2500	2883	7517	3970	8530	5058	10254	6240	11979	7423	13804

Product Class D13000 Item Group 00D90C ETIM Class ECO03539

dane techniczne / ceny netto

Ceny nie zawierają zamocowań. **Niebieskie ceny**: dostawa możliwa w jednym bloku.

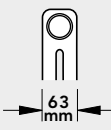
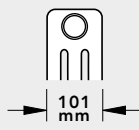
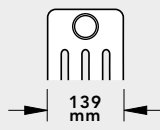
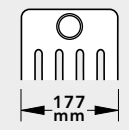
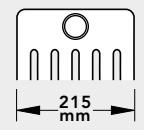
wysokość [mm] 900	2-kolumnowy		3-kolumnowy		4-kolumnowy		5-kolumnowy		6-kolumnowy		
											
rozstaw króćców 835 mm											
typ	2090		3090		4090		5090		6090		
wyktadnik n	1,2615		1,2881		1,3147		1,3139		1,3131		
poj. wody/człon w l	0,93		1,34		1,76		2,17		2,59		
waga/człon w kg	1,44		2,13		2,84		3,53		4,24		
człony	długość [mm]	[W]	PLN	[W]	PLN	[W]	PLN	[W]	PLN	[W]	PLN
4	200	273	1203	374	1301	476	1495	587	1641	699	1812
5	250	341	1349	468	1471	595	1714	734	1897	873	2110
6	300	409	1495	561	1641	714	1933	881	2153	1048	2408
7	350	478	1641	655	1812	832	2152	1028	2408	1223	2706
8	400	546	1787	749	1982	951	2371	1174	2664	1397	3004
9	450	614	1933	842	2152	1070	2591	1321	2919	1572	3303
10	500	682	2080	936	2323	1189	2810	1468	3175	1747	3601
11	550	750	2226	1029	2493	1308	3029	1615	3430	1921	3899
12	600	819	2372	1123	2664	1427	3248	1761	3686	2096	4197
13	650	887	2518	1216	2834	1546	3467	1908	3942	2270	4495
14	700	955	2664	1310	3004	1665	3686	2055	4197	2445	4794
15	750	1023	2810	1404	3175	1784	3905	2202	4453	2620	5092
16	800	1092	2956	1497	3345	1903	4124	2349	4708	2794	5390
17	850	1160	3102	1591	3515	2022	4343	2495	4964	2969	5688
18	900	1228	3248	1684	3686	2141	4562	2642	5220	3144	5986
19	950	1296	3394	1778	3856	2259	4781	2789	5475	3318	6284
20	1000	1364	3540	1871	4027	2378	5000	2936	5731	3493	6583
21	1050	1433	3686	1965	4197	2497	5219	3083	5986	3668	6881
22	1100	1501	3832	2059	4367	2616	5438	3229	6242	3842	7179
23	1150	1569	3978	2152	4538	2735	5657	3376	6498	4017	7477
24	1200	1637	4124	2246	4708	2854	5876	3523	6753	4192	7775
25	1250	1706	4270	2339	4879	2973	6096	3670	7009	4366	8074
26	1300	1774	4416	2433	5049	3092	6315	3817	7264	4541	8372
27	1350	1842	4562	2526	5219	3211	6534	3963	7520	4716	8670
28	1400	1910	4708	2620	5390	3330	6753	4110	7776	4890	8968
29	1450	1978	4854	2714	5560	3449	6972	4257	8031	5065	9266
30	1500	2047	5001	2807	5730	3568	7191	4404	8287	5240	9564
31	1550	2115	5147	2901	5901	3687	7410	4550	8542	5414	9863
32	1600	2183	5293	2994	6071	3805	7629	4697	8798	5589	10161
33	1650	2251	5439	3088	6242	3924	7848	4844	9053	5763	10459
34	1700	2319	5585	3181	6412	4043	8067	4991	9309	5938	10757
35	1750	2388	5731	3275	6582	4162	8286	5138	9565	6113	11055
36	1800	2456	5877	3369	6753	4281	8505	5284	9820	6287	11353
37	1850	2524	6023	3462	6923	4400	8724	5431	10076	6462	11652
38	1900	2592	6169	3556	7093	4519	8943	5578	10331	6637	11950
39	1950	2661	6315	3649	7264	4638	9162	5725	10587	6811	12248
40	2000	2729	6461	3743	7434	4757	9381	5872	10843	6986	12546
41	2050	2797	6607	3836	7605	4876	9600	6018	11098	7161	12844
42	2100	2865	6753	3930	7775	4995	9820	6165	11354	7335	13143
43	2150	2933	6899	4024	7945	5114	10039	6312	11609	7510	13441
44	2200	3002	7045	4117	8116	5232	10258	6459	11865	7685	13739
45	2250	3070	7191	4211	8286	5351	10477	6606	12121	7859	14037
46	2300	3138	7337	4304	8456	5470	10696	6752	12376	8034	14335
47	2350	3206	7483	4398	8627	5589	10915	6899	12632	8209	14633
48	2400	3275	7629	4491	8797	5708	11134	7046	12887	8383	14932
49	2450	3343	7775	4585	8968	5827	11353	7193	13143	8558	15230
50	2500	3411	7922	4679	9138	5946	11572	7340	13399	8733	15528

Grzejnik zaworowy

dane techniczne / ceny netto

Ceny nie zawierają zamocowań. **Niebieskie ceny** dostawa możliwa w jednym bloku.

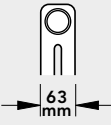
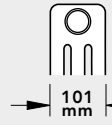
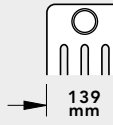
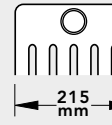
wysokość [mm]		2-kolumnowy		3-kolumnowy		4-kolumnowy		6-kolumnowy	
965									
rozstaw króćców 900 mm		63 mm		101 mm		139 mm		215 mm	
typ		2097		3097		4097		6097	
wyktadnik n		1,2660		1,2934		1,3207		1,3179	
poj. wody/człon w l		0,99		1,42		1,87		2,75	
waga/człon w kg		1,54		2,28		3,04		4,53	
człony	długość [mm]	[W]		[W]		[W]		[W]	
		PLN	PLN	PLN	PLN	PLN	PLN	PLN	PLN
4	200	291	1211	399	1333	506	1560	744	1893
5	250	364	1359	498	1512	633	1795	930	2211
6	300	437	1507	598	1690	759	2031	1115	2530
7	350	510	1656	698	1869	886	2266	1301	2848
8	400	582	1804	798	2047	1013	2501	1487	3167
9	450	655	1952	897	2226	1139	2737	1673	3485
10	500	728	2100	997	2404	1266	2972	1859	3804
11	550	801	2248	1097	2583	1392	3207	2045	4122
12	600	874	2396	1196	2761	1519	3442	2231	4441
13	650	946	2544	1296	2940	1645	3678	2417	4759
14	700	1019	2692	1396	3118	1772	3913	2603	5078
15	750	1092	2840	1495	3297	1899	4148	2789	5396
16	800	1165	2988	1595	3475	2025	4383	2975	5715
17	850	1238	3136	1695	3654	2152	4619	3160	6033
18	900	1310	3284	1794	3832	2278	4854	3346	6352
19	950	1383	3433	1894	4011	2405	5089	3532	6670
20	1000	1456	3581	1994	4189	2531	5325	3718	6989
21	1050	1529	3729	2093	4368	2658	5560	3904	7307
22	1100	1602	3877	2193	4546	2785	5795	4090	7626
23	1150	1674	4025	2293	4725	2911	6030	4276	7944
24	1200	1747	4173	2393	4903	3038	6266	4462	8263
25	1250	1820	4321	2492	5082	3164	6501	4648	8581
26	1300	1893	4469	2592	5260	3291	6736	4834	8900
27	1350	1966	4617	2692	5439	3417	6972	5020	9218
28	1400	2038	4765	2791	5617	3544	7207	5205	9537
29	1450	2111	4913	2891	5796	3671	7442	5391	9855
30	1500	2184	5061	2991	5974	3797	7677	5577	10174
31	1550	2257	5209	3090	6153	3924	7913	5763	10492
32	1600	2330	5358	3190	6331	4050	8148	5949	10811
33	1650	2402	5506	3290	6510	4177	8383	6135	11129
34	1700	2475	5654	3389	6688	4303	8619	6321	11448
35	1750	2548	5802	3489	6867	4430	8854	6507	11766
36	1800	2621	5950	3589	7045	4557	9089	6693	12085
37	1850	2694	6098	3689	7224	4683	9324	6879	12403
38	1900	2766	6246	3788	7402	4810	9560	7065	12722
39	1950	2839	6394	3888	7581	4936	9795	7250	13040
40	2000	2912	6542	3988	7759	5063	10030	7436	13359
41	2050	2985	6690	4087	7938	5189	10265	7622	13677
42	2100	3058	6838	4187	8116	5316	10501	7808	13996
43	2150	3130	6986	4287	8295	5443	10736	7994	14314
44	2200	3203	7135	4386	8473	5569	10971	8180	14633
45	2250	3276	7283	4486	8652	5696	11207	8366	14951
46	2300	3349	7431	4586	8830	5822	11442	8552	15270
47	2350	3422	7579	4685	9009	5949	11677	8738	15588
48	2400	3494	7727	4785	9187	6075	11912	8924	15907
49	2450	3567	7875	4885	9366	6202	12148	9110	16225
50	2500	3640	8023	4985	9544	6329	12383	9296	16544

Product Class D13000	Item Group 00D90C	ETIM Class ECO03539
-------------------------	----------------------	------------------------

dane techniczne / ceny netto

Ceny nie zawierają zamocowań. **Niebieskie ceny** dostawa możliwa w jednym bloku.

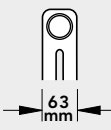
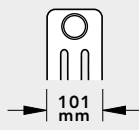
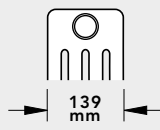
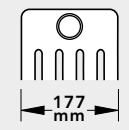
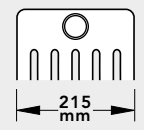
wysokość [mm] 1000	2-kolumnowy		3-kolumnowy		4-kolumnowy		5-kolumnowy		6-kolumnowy		
											
rozstaw króćców 935 mm	63 mm		101 mm		139 mm		177 mm		215 mm		
typ	2100		3100		4100		5100		6100		
wyktadnik n	1,2684		1,2961		1,3237		1,3220		1,3203		
poj. wody/człon w l	1,02		1,47		1,93		2,38		2,84		
waga/człon w kg	1,59		2,36		3,14		3,91		4,69		
człony	długość [mm]	[W]		[W]		[W]		[W]		[W]	
		PLN	PLN	PLN	PLN	PLN	PLN	PLN	PLN		
4	200	301	1219	412	1333	523	1560	645	1714	768	1901
5	250	376	1369	515	1512	653	1795	807	1988	960	2221
6	300	452	1520	618	1690	784	2031	968	2262	1152	2542
7	350	527	1670	721	1869	915	2266	1129	2536	1344	2862
8	400	602	1820	824	2047	1045	2501	1290	2810	1536	3183
9	450	677	1970	927	2226	1176	2737	1452	3084	1728	3503
10	500	753	2120	1030	2404	1307	2972	1613	3357	1920	3824
11	550	828	2270	1133	2583	1437	3207	1774	3631	2111	4144
12	600	903	2420	1236	2761	1568	3442	1936	3905	2303	4465
13	650	978	2570	1339	2940	1699	3678	2097	4179	2495	4785
14	700	1054	2720	1442	3118	1829	3913	2258	4453	2687	5106
15	750	1129	2870	1545	3297	1960	4148	2420	4727	2879	5426
16	800	1204	3020	1648	3475	2091	4383	2581	5000	3071	5747
17	850	1279	3171	1750	3654	2221	4619	2742	5274	3263	6067
18	900	1355	3321	1853	3832	2352	4854	2904	5548	3455	6388
19	950	1430	3471	1956	4011	2483	5089	3065	5822	3647	6708
20	1000	1505	3621	2059	4189	2613	5325	3226	6096	3839	7029
21	1050	1580	3771	2162	4368	2744	5560	3388	6370	4031	7349
22	1100	1656	3921	2265	4546	2875	5795	3549	6643	4223	7670
23	1150	1731	4071	2368	4725	3005	6030	3710	6917	4415	7990
24	1200	1806	4221	2471	4903	3136	6266	3871	7191	4607	8311
25	1250	1882	4371	2574	5082	3267	6501	4033	7465	4799	8631
26	1300	1957	4521	2677	5260	3397	6736	4194	7739	4991	8951
27	1350	2032	4671	2780	5439	3528	6972	4355	8013	5183	9272
28	1400	2107	4822	2883	5617	3659	7207	4517	8287	5375	9592
29	1450	2183	4972	2986	5796	3789	7442	4678	8560	5567	9913
30	1500	2258	5122	3089	5974	3920	7677	4839	8834	5759	10233
31	1550	2333	5272	3192	6153	4051	7913	5001	9108	5950	10554
32	1600	2408	5422	3295	6331	4181	8148	5162	9382	6142	10874
33	1650	2484	5572	3398	6510	4312	8383	5323	9656	6334	11195
34	1700	2559	5722	3501	6688	4443	8619	5485	9930	6526	11515
35	1750	2634	5872	3604	6867	4573	8854	5646	10203	6718	11836
36	1800	2709	6022	3707	7045	4704	9089	5807	10477	6910	12156
37	1850	2785	6172	3810	7224	4835	9324	5968	10751	7102	12477
38	1900	2860	6322	3913	7402	4965	9560	6130	11025	7294	12797
39	1950	2935	6473	4016	7581	5096	9795	6291	11299	7486	13118
40	2000	3010	6623	4119	7759	5227	10030	6452	11573	7678	13438
41	2050	3086	6773	4222	7938	5357	10265	6614	11846	7870	13759
42	2100	3161	6923	4325	8116	5488	10501	6775	12120	8062	14079
43	2150	3236	7073	4428	8295	5619	10736	6936	12394	8254	14400
44	2200	3311	7223	4531	8473	5749	10971	7098	12668	8446	14720
45	2250	3387	7373	4634	8652	5880	11207	7259	12942	8638	15041
46	2300	3462	7523	4737	8830	6011	11442	7420	13216	8830	15361
47	2350	3537	7673	4840	9009	6141	11677	7582	13489	9022	15682
48	2400	3612	7823	4943	9187	6272	11912	7743	13763	9214	16002
49	2450	3688	7973	5046	9366	6403	12148	7904	14037	9406	16323
50	2500	3763	8124	5149	9544	6534	12383	8066	14311	9598	16643

Grzejnik zaworowy

dane techniczne / ceny netto

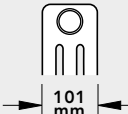
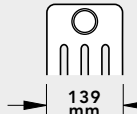
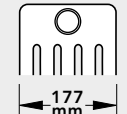
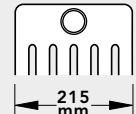

Ceny nie zawierają zamocowań. **Niebieskie ceny**: dostawa możliwa w jednym bloku.

wysokość [mm]				3-kolumnowy		4-kolumnowy		5-kolumnowy		6-kolumnowy	
 1065											
rozstaw króćców 1000 mm				101 mm		139 mm		177 mm		215 mm	
typ				3107		4107		5107		6107	
wykładnik n				1,3009		1,3288		1,3267		1,3245	
poj. wody/człon w l				1,55		2,04		2,52		3,00	
waga/człon w kg				2,46		3,24		4,15		4,98	
człony	dtu- gość [mm]	[W]	PLN	[W]	PLN	[W]	PLN	[W]	PLN	[W]	PLN
4	200			436	1414	553	1666	683	1860	813	2079
5	250			545	1613	691	1927	854	2171	1016	2445
6	300			654	1812	830	2189	1024	2481	1219	2810
7	350			763	2011	968	2451	1195	2792	1422	3175
8	400			873	2209	1106	2712	1366	3102	1625	3540
9	450			982	2408	1245	2974	1536	3412	1828	3905
10	500			1091	2607	1383	3236	1707	3723	2032	4270
11	550			1200	2806	1521	3497	1878	4033	2235	4635
12	600			1309	3004	1659	3759	2049	4343	2438	5000
13	650			1418	3203	1798	4020	2219	4654	2641	5365
14	700			1527	3402	1936	4282	2390	4964	2844	5731
15	750			1636	3601	2074	4544	2561	5274	3047	6096
16	800			1745	3800	2213	4805	2732	5585	3250	6461
17	850			1854	3998	2351	5067	2902	5895	3454	6826
18	900			1963	4197	2489	5329	3073	6205	3657	7191
19	950			2072	4396	2628	5590	3244	6516	3860	7556
20	1000			2181	4595	2766	5852	3414	6826	4063	7921
21	1050			2290	4794	2904	6114	3585	7137	4266	8286
22	1100			2400	4992	3042	6375	3756	7447	4469	8651
23	1150			2509	5191	3181	6637	3927	7757	4672	9017
24	1200			2618	5390	3319	6899	4097	8068	4876	9382
25	1250			2727	5589	3457	7160	4268	8378	5079	9747
26	1300			2836	5788	3596	7422	4439	8688	5282	10112
27	1350			2945	5986	3734	7684	4609	8999	5485	10477
28	1400			3054	6185	3872	7945	4780	9309	5688	10842
29	1450			3163	6384	4010	8207	4951	9619	5891	11207
30	1500			3272	6583	4149	8469	5122	9930	6095	11572
31	1550			3381	6781	4287	8730	5292	10240	6298	11937
32	1600			3490	6980	4425	8992	5463	10551	6501	12303
33	1650			3599	7179	4564	9253	5634	10861	6704	12668
34	1700			3708	7378	4702	9515	5804	11171	6907	13033
35	1750			3817	7577	4840	9777	5975	11482	7110	13398
36	1800			3927	7775	4978	10038	6146	11792	7313	13763
37	1850			4036	7974	5117	10300	6317	12102	7517	14128
38	1900			4145	8173	5255	10562	6487	12413	7720	14493
39	1950			4254	8372	5393	10823	6658	12723	7923	14858
40	2000			4363	8571	5532	11085	6829	13033	8126	15223
41	2050			4472	8769	5670	11347	7000	13344	8329	15589
42	2100			4581	8968	5808	11608	7170	13654	8532	15954
43	2150			4690	9167	5946	11870	7341	13964	8735	16319
44	2200			4799	9366	6085	12132	7512	14275	8939	16684
45	2250			4908	9565	6223	12393	7682	14585	9142	17049
46	2300			5017	9763	6361	12655	7853	14896	9345	17414
47	2350			5126	9962	6500	12917	8024	15206	9548	17779
48	2400			5235	10161	6638	13178	8195	15516	9751	18144
49	2450			5344	10360	6776	13440	8365	15827	9954	18509
50	2500			5454	10559	6915	13702	8536	16137	10158	18875

Product Class
D13000Item Group
00D90CETIM Class
EC003539

dane techniczne / ceny netto

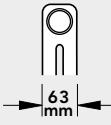
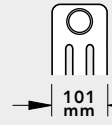
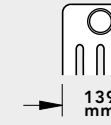
Ceny nie zawierają zamocowań. **Niebieskie ceny**: dostawa możliwa w jednym bloku.

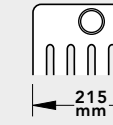
↑↓ wysokość [mm] 1100	2-kolumnowy		3-kolumnowy		4-kolumnowy		5-kolumnowy		6-kolumnowy		
											
↕ rozstaw króćców 1035 mm	63 mm		101 mm		139 mm		177 mm		215 mm		
typ	2110		3110		4110		5110		6110		
wyktadnik n	1,2754		1,3034		1,3314		1,3290		1,3266		
poj. wody/człon w l	1,11		1,60		2,10		2,59		3,10		
waga/człon w kg	1,75		2,59		3,44		4,28		5,14		
człony	↔ długość [mm]	[W]	PLN	[W]	PLN	[W]	PLN	[W]	PLN	[W]	PLN
4	200	329	1260	449	1438	570	1690	703	1901	837	2128
5	250	412	1420	562	1643	712	1958	879	2221	1046	2505
6	300	494	1581	674	1848	854	2226	1055	2542	1255	2883
7	350	576	1741	786	2053	997	2493	1230	2862	1464	3260
8	400	658	1901	899	2258	1139	2761	1406	3183	1673	3637
9	450	741	2061	1011	2463	1281	3029	1582	3503	1882	4015
10	500	823	2222	1123	2668	1424	3297	1758	3824	2092	4392
11	550	905	2382	1236	2873	1566	3564	1933	4144	2301	4769
12	600	988	2542	1348	3077	1709	3832	2109	4465	2510	5146
13	650	1070	2702	1460	3282	1851	4100	2285	4785	2719	5524
14	700	1152	2863	1573	3487	1993	4368	2461	5106	2928	5901
15	750	1235	3023	1685	3692	2136	4635	2637	5426	3137	6278
16	800	1317	3183	1797	3897	2278	4903	2812	5747	3347	6655
17	850	1399	3343	1910	4102	2420	5171	2988	6067	3556	7033
18	900	1481	3504	2022	4307	2563	5439	3164	6388	3765	7410
19	950	1564	3664	2134	4512	2705	5706	3340	6708	3974	7787
20	1000	1646	3824	2247	4716	2848	5974	3515	7029	4183	8165
21	1050	1728	3984	2359	4921	2990	6242	3691	7349	4392	8542
22	1100	1811	4145	2471	5126	3132	6510	3867	7670	4602	8919
23	1150	1893	4305	2584	5331	3275	6777	4043	7990	4811	9296
24	1200	1975	4465	2696	5536	3417	7045	4218	8311	5020	9674
25	1250	2058	4626	2809	5741	3560	7313	4394	8631	5229	10051
26	1300	2140	4786	2921	5946	3702	7581	4570	8951	5438	10428
27	1350	2222	4946	3033	6150	3844	7848	4746	9272	5647	10806
28	1400	2304	5106	3146	6355	3987	8116	4922	9592	5856	11183
29	1450	2387	5267	3258	6560	4129	8384	5097	9913	6066	11560
30	1500	2469	5427	3370	6765	4271	8652	5273	10233	6275	11937
31	1550	2551	5587	3483	6970	4414	8919	5449	10554	6484	12315
32	1600	2634	5747	3595	7175	4556	9187	5625	10874	6693	12692
33	1650	2716	5908	3707	7380	4699	9455	5800	11195	6902	13069
34	1700	2798	6068	3820	7585	4841	9723	5976	11515	7111	13447
35	1750	2881	6228	3932	7789	4983	9990	6152	11836	7321	13824
36	1800	2963	6388	4044	7994	5126	10258	6328	12156	7530	14201
37	1850	3045	6549	4157	8199	5268	10526	6503	12477	7739	14578
38	1900	3127	6709	4269	8404	5410	10794	6679	12797	7948	14956
39	1950	3210	6869	4381	8609	5553	11061	6855	13118	8157	15333
40	2000	3292	7029	4494	8814	5695	11329	7031	13438	8366	15710
41	2050	3374	7190	4606	9019	5838	11597	7207	13759	8576	16087
42	2100	3457	7350	4718	9224	5980	11865	7382	14079	8785	16465
43	2150	3539	7510	4831	9428	6122	12132	7558	14400	8994	16842
44	2200	3621	7670	4943	9633	6265	12400	7734	14720	9203	17219
45	2250	3704	7831	5055	9838	6407	12668	7910	15041	9412	17597
46	2300	3786	7991	5168	10043	6549	12936	8085	15361	9621	17974
47	2350	3868	8151	5280	10248	6692	13203	8261	15682	9831	18351
48	2400	3950	8311	5392	10453	6834	13471	8437	16002	10040	18728
49	2450	4033	8472	5505	10658	6977	13739	8613	16323	10249	19106
50	2500	4115	8632	5617	10863	7119	14007	8789	16643	10458	19483

dane techniczne / ceny netto

Ceny nie zawierają zamocowań. **Niebieskie ceny** dostawa możliwa w jednym bloku.

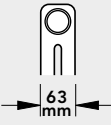
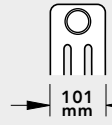
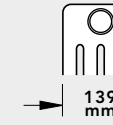
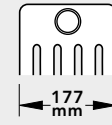
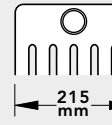
↑↓ wysokość [mm] 1200	2-kolumnowy		3-kolumnowy		4-kolumnowy		5-kolumnowy		6-kolumnowy		
											
↕ rozstaw króćców 1135 mm	63 mm		101 mm		139 mm		177 mm		215 mm		
typ	2120		3120		4120		5120		6120		
wyktadnik n	1,2823		1,3101		1,3378		1,3350		1,3321		
poj. wody/człon w l	1,19		1,73		2,27		2,80		3,33		
waga/człon w kg	1,90		2,81		3,74		4,65		5,58		
człony	↔ długość [mm]	[W]		[W]		[W]		[W]		[W]	
		PLN	PLN	PLN	PLN	PLN	PLN	PLN	PLN	PLN	
4	200	357	1325	487	1560	616	1804	761	2079	905	2331
5	250	447	1501	609	1795	770	2100	951	2445	1131	2759
6	300	536	1678	730	2031	924	2396	1141	2810	1358	3187
7	350	625	1854	852	2266	1078	2692	1331	3175	1584	3615
8	400	715	2031	974	2501	1232	2988	1521	3540	1810	4043
9	450	804	2207	1095	2737	1386	3284	1712	3905	2037	4471
10	500	894	2384	1217	2972	1540	3581	1902	4270	2263	4899
11	550	983	2560	1339	3207	1694	3877	2092	4635	2489	5327
12	600	1072	2737	1460	3442	1848	4173	2282	5000	2715	5755
13	650	1162	2913	1582	3678	2003	4469	2472	5365	2942	6183
14	700	1251	3090	1704	3913	2157	4765	2662	5731	3168	6611
15	750	1340	3266	1826	4148	2311	5061	2853	6096	3394	7039
16	800	1430	3443	1947	4383	2465	5357	3043	6461	3621	7467
17	850	1519	3619	2069	4619	2619	5654	3233	6826	3847	7895
18	900	1608	3796	2191	4854	2773	5950	3423	7191	4073	8323
19	950	1698	3972	2312	5089	2927	6246	3613	7556	4300	8751
20	1000	1787	4149	2434	5325	3081	6542	3803	7921	4526	9179
21	1050	1876	4325	2556	5560	3235	6838	3994	8286	4752	9607
22	1100	1966	4502	2677	5795	3389	7134	4184	8651	4978	10035
23	1150	2055	4678	2799	6030	3543	7430	4374	9017	5205	10463
24	1200	2144	4855	2921	6266	3697	7727	4564	9382	5431	10891
25	1250	2234	5031	3043	6501	3851	8023	4754	9747	5657	11319
26	1300	2323	5208	3164	6736	4005	8319	4944	10112	5884	11747
27	1350	2412	5384	3286	6972	4159	8615	5135	10477	6110	12175
28	1400	2502	5561	3408	7207	4313	8911	5325	10842	6336	12603
29	1450	2591	5737	3529	7442	4467	9207	5515	11207	6562	13031
30	1500	2681	5914	3651	7677	4621	9504	5705	11572	6789	13459
31	1550	2770	6090	3773	7913	4775	9800	5895	11937	7015	13887
32	1600	2859	6267	3894	8148	4929	10096	6085	12303	7241	14315
33	1650	2949	6443	4016	8383	5083	10392	6276	12668	7468	14743
34	1700	3038	6620	4138	8619	5237	10688	6466	13033	7694	15171
35	1750	3127	6796	4260	8854	5391	10984	6656	13398	7920	15599
36	1800	3217	6973	4381	9089	5545	11280	6846	13763	8146	16027
37	1850	3306	7149	4503	9324	5699	11577	7036	14128	8373	16455
38	1900	3395	7326	4625	9560	5854	11873	7226	14493	8599	16883
39	1950	3485	7502	4746	9795	6008	12169	7417	14858	8825	17311
40	2000	3574	7679	4868	10030	6162	12465	7607	15223	9052	17739
41	2050	3663	7855	4990	10265	6316	12761	7797	15589	9278	18167
42	2100	3753	8032	5111	10501	6470	13057	7987	15954	9504	18595
43	2150	3842	8208	5233	10736	6624	13353	8177	16319	9730	19023
44	2200	3931	8385	5355	10971	6778	13650	8367	16684	9957	19451
45	2250	4021	8561	5477	11207	6932	13946	8558	17049	10183	19879
46	2300	4110	8738	5598	11442	7086	14242	8748	17414	10409	20307
47	2350	4199	8914	5720	11677	7240	14538	8938	17779	10636	20735
48	2400	4289	9091	5842	11912	7394	14834	9128	18144	10862	21163
49	2450	4378	9267	5963	12148	7548	15130	9318	18509	11088	21591
50	2500	4468	9444	6085	12383	7702	15427	9509	18875	11315	22019

Product Class D13000	Item Group 00D90C	ETIM Class EC003539
-------------------------	----------------------	------------------------

dane techniczne / ceny netto

Ceny nie zawierają zamocowań. **Niebieskie ceny:** dostawa możliwa w jednym bloku.

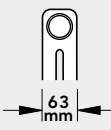
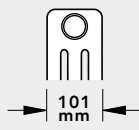
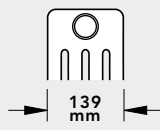
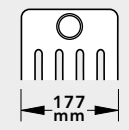
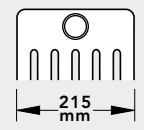
wysokość [mm] 1500	2-kolumnowy		3-kolumnowy		4-kolumnowy		5-kolumnowy		6-kolumnowy		
											
rozstaw króćców 1435 mm											
typ	2150		3150		4150		5150		6150		
wyktadnik n	1,3023		1,3264		1,3504		1,3469		1,3433		
poj. wody/człon w l	1,46		2,11		2,77		3,42		4,08		
waga/człon w kg	2,36		3,49		4,64		5,77		6,92		
człony	długość [mm]	[W]		[W]		[W]		[W]		[W]	
		PLN	PLN	PLN	PLN	PLN	PLN	PLN	PLN		
4	200	443	1512	599	1844	756	2218	933	2591	1110	2972
5	250	553	1735	749	2150	945	2617	1166	3084	1387	3560
6	300	664	1958	899	2457	1134	3017	1399	3576	1664	4148
7	350	774	2181	1049	2763	1323	3416	1632	4069	1942	4737
8	400	885	2404	1198	3069	1512	3816	1865	4562	2219	5325
9	450	996	2627	1348	3376	1701	4216	2099	5055	2497	5913
10	500	1106	2850	1498	3682	1890	4615	2332	5548	2774	6501
11	550	1217	3073	1648	3988	2078	5015	2565	6041	3052	7090
12	600	1328	3297	1798	4294	2267	5415	2798	6534	3329	7678
13	650	1438	3520	1947	4601	2456	5814	3031	7027	3606	8266
14	700	1549	3743	2097	4907	2645	6214	3265	7520	3884	8854
15	750	1660	3966	2247	5213	2834	6613	3498	8013	4161	9443
16	800	1770	4189	2397	5519	3023	7013	3731	8505	4439	10031
17	850	1881	4412	2547	5826	3212	7413	3964	8998	4716	10619
18	900	1992	4635	2696	6132	3401	7812	4197	9491	4993	11207
19	950	2102	4858	2846	6438	3590	8212	4430	9984	5271	11796
20	1000	2213	5082	2996	6745	3779	8612	4664	10477	5548	12384
21	1050	2323	5305	3146	7051	3968	9011	4897	10970	5826	12972
22	1100	2434	5528	3296	7357	4157	9411	5130	11463	6103	13560
23	1150	2545	5751	3445	7663	4346	9810	5363	11956	6380	14149
24	1200	2655	5974	3595	7970	4535	10210	5596	12449	6658	14737
25	1250	2766	6197	3745	8276	4724	10610	5830	12942	6935	15325
26	1300	2877	6420	3895	8582	4913	11009	6063	13434	7213	15913
27	1350	2987	6644	4045	8889	5102	11409	6296	13927	7490	16501
28	1400	3098	6867	4194	9195	5291	11809	6529	14420	7767	17090
29	1450	3209	7090	4344	9501	5480	12208	6762	14913	8045	17678
30	1500	3319	7313	4494	9807	5669	12608	6995	15406	8322	18266
31	1550	3430	7536	4644	10114	5857	13008	7229	15899	8600	18854
32	1600	3540	7759	4794	10420	6046	13407	7462	16392	8877	19443
33	1650	3651	7982	4943	10726	6235	13807	7695	16885	9155	20031
34	1700	3762	8205	5093	11033	6424	14206	7928	17378	9432	20619
35	1750	3872	8429	5243	11339	6613	14606	8161	17871	9709	21207
36	1800	3983	8652	5393	11645	6802	15006	8394	18363	9987	21796
37	1850	4094	8875	5543	11951	6991	15405	8628	18856	10264	22384
38	1900	4204	9098	5692	12258	7180	15805	8861	19349	10542	22972
39	1950	4315	9321	5842	12564	7369	16205	9094	19842	10819	23560
40	2000	4426	9544	5992	12870	7558	16604	9327	20335	11096	24149
41	2050	4536	9767	6142	13176	7747	17004	9560	20828	11374	24737
42	2100	4647	9990	6292	13483	7936	17403	9794	21321	11651	25325
43	2150	4758	10214	6441	13789	8125	17803	10027	21814	11929	25913
44	2200	4868	10437	6591	14095	8314	18203	10260	22307	12206	26502
45	2250	4979	10660	6741	14402	8503	18602	10493	22800	12483	27090
46	2300	5089	10883	6891	14708	8692	19002	10726	23292	12761	27678
47	2350	5200	11106	7041	15014	8881	19402	10959	23785	13038	28266
48	2400	5311	11329	7190	15320	9070	19801	11193	24278	13316	28855
49	2450	5421	11552	7340	15627	9259	20201	11426	24771	13593	29443
50	2500	5532	11776	7490	15933	9448	20601	11659	25264	13871	30031

Grzejnik zaworowy

dane techniczne / ceny netto

Ceny nie zawierają zamocowań. **Niebieskie ceny**: dostawa możliwa w jednym bloku.

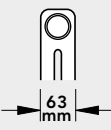
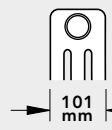
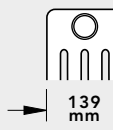
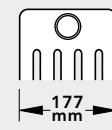
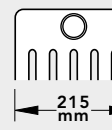
wysokość [mm] 1800		2-kolumnowy		3-kolumnowy		4-kolumnowy		5-kolumnowy		6-kolumnowy	
rozstaw króćców 1735 mm											
typ		2180		3180		4180		5180		6180	
wykładnik n		1,3197		1,3369		1,3541		1,3504		1,3467	
poj. wody/człon w l		1,72		2,49		3,27		4,04		4,82	
waga/człon w kg		2,82		4,17		5,53		6,88		8,25	
człony	długość [mm]	[W]	PLN	[W]	PLN	[W]	PLN	[W]	PLN	[W]	PLN
4	200	529	1649	712	2120	896	2534	1105	2964	1313	3402
5	250	661	1907	890	2495	1120	3013	1381	3550	1642	4098
6	300	793	2165	1068	2871	1344	3491	1657	4136	1970	4794
7	350	926	2422	1247	3246	1567	3970	1933	4722	2298	5489
8	400	1058	2680	1425	3621	1791	4449	2209	5309	2627	6185
9	450	1190	2937	1603	3996	2015	4927	2485	5895	2955	6881
10	500	1322	3195	1781	4372	2239	5406	2761	6481	3284	7577
11	550	1455	3453	1959	4747	2463	5885	3038	7067	3612	8272
12	600	1587	3710	2137	5122	2687	6364	3314	7653	3940	8968
13	650	1719	3968	2315	5497	2911	6842	3590	8240	4269	9664
14	700	1851	4226	2493	5873	3135	7321	3866	8826	4597	10360
15	750	1983	4483	2671	6248	3359	7800	4142	9412	4925	11055
16	800	2116	4741	2849	6623	3583	8279	4418	9998	5254	11751
17	850	2248	4998	3027	6998	3807	8757	4694	10584	5582	12447
18	900	2380	5256	3205	7374	4031	9236	4971	11171	5910	13143
19	950	2512	5514	3384	7749	4254	9715	5247	11757	6239	13838
20	1000	2645	5771	3562	8124	4478	10193	5523	12343	6567	14534
21	1050	2777	6029	3740	8499	4702	10672	5799	12929	6895	15230
22	1100	2909	6286	3918	8875	4926	11151	6075	13515	7224	15926
23	1150	3041	6544	4096	9250	5150	11630	6351	14102	7552	16621
24	1200	3174	6802	4274	9625	5374	12108	6627	14688	7880	17317
25	1250	3306	7059	4452	10000	5598	12587	6904	15274	8209	18013
26	1300	3438	7317	4630	10376	5822	13066	7180	15860	8537	18709
27	1350	3570	7574	4808	10751	6046	13544	7456	16446	8865	19404
28	1400	3702	7832	4986	11126	6270	14023	7732	17033	9194	20100
29	1450	3835	8090	5164	11501	6494	14502	8008	17619	9522	20796
30	1500	3967	8347	5342	11877	6718	14981	8284	18205	9851	21492
31	1550	4099	8605	5520	12252	6942	15459	8560	18791	10179	22187
32	1600	4231	8863	5699	12627	7165	15938	8836	19377	10507	22883
33	1650	4364	9120	5877	13002	7389	16417	9113	19964	10836	23579
34	1700	4496	9378	6055	13378	7613	16895	9389	20550	11164	24275
35	1750	4628	9635	6233	13753	7837	17374	9665	21136	11492	24970
36	1800	4760	9893	6411	14128	8061	17853	9941	21722	11821	25666
37	1850	4893	10151	6589	14503	8285	18332	10217	22308	12149	26362
38	1900	5025	10408	6767	14879	8509	18810	10493	22895	12477	27058
39	1950	5157	10666	6945	15254	8733	19289	10769	23481	12806	27753
40	2000	5289	10923	7123	15629	8957	19768	11046	24067	13134	28449
41	2050	5421	11181	7301	16004	9181	20247	11322	24653	13462	29145
42	2100	5554	11439	7479	16380	9405	20725	11598	25239	13791	29841
43	2150	5686	11696	7657	16755	9629	21204	11874	25826	14119	30536
44	2200	5818	11954	7836	17130	9852	21683	12150	26412	14447	31232
45	2250	5950	12211	8014	17505	10076	22161	12426	26998	14776	31928
46	2300	6083	12469	8192	17881	10300	22640	12702	27584	15104	32624
47	2350	6215	12727	8370	18256	10524	23119	12979	28170	15432	33319
48	2400	6347	12984	8548	18631	10748	23598	13255	28757	15761	34015
49	2450	6479	13242	8726	19006	10972	24076	13531	29343	16089	34711
50	2500	6612	13500	8904	19382	11196	24555	13807	29929	16418	35407

Product Class D13000	Item Group OOD90C	ETIM Class ECO03539
-------------------------	----------------------	------------------------

dane techniczne / ceny netto

Ceny nie zawierają zamocowań. **Niebieskie ceny:** dostawa możliwa w jednym bloku.

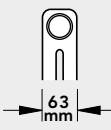
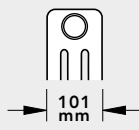
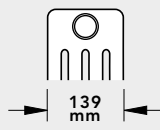
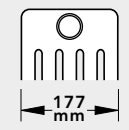
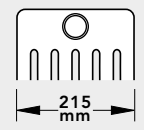
wysokość [mm] 2000	2-kolumnowy		3-kolumnowy		4-kolumnowy		5-kolumnowy		6-kolumnowy		
											
rozstaw króćców 1935 mm	63 mm		101 mm		139 mm		177 mm		215 mm		
typ	2200		3200		4200		5200		6200		
wyktadnik n	1,3289		1,3408		1,3526		1,3486		1,3446		
poj. wody/człon w l	1,90		2,75		3,61		4,46		5,31		
waga/człon w kg	3,12		4,62		6,13		7,63		9,15		
człony	długość [mm]	[W]		[W]		[W]		[W]		[W]	
		PLN	PLN	PLN	PLN	PLN	PLN	PLN	PLN		
4	200	587	1771	788	2234	989	2737	1219	3240	1449	3718
5	250	734	2059	986	2637	1237	3266	1524	3895	1812	4493
6	300	881	2347	1183	3041	1484	3796	1829	4550	2174	5268
7	350	1028	2635	1380	3445	1732	4325	2134	5205	2536	6043
8	400	1175	2923	1577	3848	1979	4854	2439	5860	2899	6818
9	450	1321	3211	1774	4252	2226	5384	2744	6516	3261	7593
10	500	1468	3499	1971	4656	2474	5913	3049	7171	3623	8368
11	550	1615	3787	2168	5059	2721	6443	3353	7826	3986	9142
12	600	1762	4075	2365	5463	2968	6972	3658	8481	4348	9917
13	650	1909	4363	2562	5866	3216	7502	3963	9136	4710	10692
14	700	2056	4651	2759	6270	3463	8031	4268	9792	5073	11467
15	750	2202	4939	2957	6674	3710	8560	4573	10447	5435	12242
16	800	2349	5227	3154	7077	3958	9090	4878	11102	5797	13017
17	850	2496	5516	3351	7481	4205	9619	5182	11757	6160	13792
18	900	2643	5804	3548	7885	4452	10149	5487	12412	6522	14566
19	950	2790	6092	3745	8288	4700	10678	5792	13067	6884	15341
20	1000	2937	6380	3942	8692	4947	11208	6097	13723	7247	16116
21	1050	3083	6668	4139	9096	5195	11737	6402	14378	7609	16891
22	1100	3230	6956	4336	9499	5442	12266	6707	15033	7971	17666
23	1150	3377	7244	4533	9903	5689	12796	7012	15688	8334	18441
24	1200	3524	7532	4730	10307	5937	13325	7316	16343	8696	19216
25	1250	3671	7820	4928	10710	6184	13855	7621	16999	9059	19991
26	1300	3818	8108	5125	11114	6431	14384	7926	17654	9421	20765
27	1350	3964	8396	5322	11518	6679	14914	8231	18309	9783	21540
28	1400	4111	8684	5519	11921	6926	15443	8536	18964	10146	22315
29	1450	4258	8972	5716	12325	7173	15972	8841	19619	10508	23090
30	1500	4405	9260	5913	12729	7421	16502	9146	20274	10870	23865
31	1550	4552	9548	6110	13132	7668	17031	9450	20930	11233	24640
32	1600	4699	9836	6307	13536	7916	17561	9755	21585	11595	25415
33	1650	4845	10124	6504	13939	8163	18090	10060	22240	11957	26189
34	1700	4992	10412	6701	14343	8410	18620	10365	22895	12320	26964
35	1750	5139	10700	6899	14747	8658	19149	10670	23550	12682	27739
36	1800	5286	10988	7096	15150	8905	19678	10975	24205	13044	28514
37	1850	5433	11276	7293	15554	9152	20208	11279	24861	13407	29289
38	1900	5580	11564	7490	15958	9400	20737	11584	25516	13769	30064
39	1950	5726	11852	7687	16361	9647	21267	11889	26171	14131	30839
40	2000	5873	12140	7884	16765	9894	21796	12194	26826	14494	31613
41	2050	6020	12428	8081	17169	10142	22326	12499	27481	14856	32388
42	2100	6167	12716	8278	17572	10389	22855	12804	28137	15218	33163
43	2150	6314	13004	8475	17976	10636	23384	13109	28792	15581	33938
44	2200	6461	13292	8672	18380	10884	23914	13413	29447	15943	34713
45	2250	6607	13580	8870	18783	11131	24443	13718	30102	16305	35488
46	2300	6754	13868	9067	19187	11379	24973	14023	30757	16668	36263
47	2350	6901	14156	9264	19591	11626	25502	14328	31412	17030	37037
48	2400	7048	14444	9461	19994	11873	26032	14633	32068	17392	37812
49	2450	7195	14732	9658	20398	12121	26561	14938	32723	17755	38587
50	2500	7342	15021	9855	20802	12368	27091	15243	33378	18117	39362

Grzejnik zaworowy

dane techniczne / ceny netto

Ceny nie zawierają zamocowań. **Niebieskie ceny:** dostawa możliwa w jednym bloku.

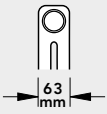
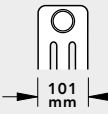
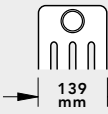
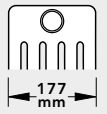
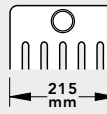
wysokość [mm] 2200		2-kolumnowy		3-kolumnowy		4-kolumnowy		5-kolumnowy		6-kolumnowy	
rozstaw króćców 2135 mm											
typ		2220		3220		4220		5220		6220	
wykładnik n		1,3356		1,3421		1,3485		1,3437		1,3389	
poj. wody/człon w l		2,08		3,01		3,94		4,87		5,81	
waga/człon w kg		3,43		5,07		6,73		8,38		10,04	
człony	długość [mm]	[W]	PLN	[W]	PLN	[W]	PLN	[W]	PLN	[W]	PLN
4	200	647	1909	865	2445	1084	2980	1335	3516	1586	4035
5	250	808	2232	1081	2901	1355	3570	1668	4240	1982	4889
6	300	970	2554	1298	3357	1626	4161	2002	4964	2379	5743
7	350	1131	2877	1514	3814	1897	4751	2336	5688	2775	6597
8	400	1293	3199	1730	4270	2167	5341	2669	6412	3171	7451
9	450	1455	3522	1947	4727	2438	5931	3003	7136	3568	8305
10	500	1616	3844	2163	5183	2709	6522	3337	7861	3964	9159
11	550	1778	4167	2379	5639	2980	7112	3670	8585	4361	10013
12	600	1940	4489	2595	6096	3251	7702	4004	9309	4757	10867
13	650	2101	4812	2812	6552	3522	8292	4338	10033	5153	11721
14	700	2263	5135	3028	7009	3793	8883	4672	10757	5550	12575
15	750	2424	5457	3244	7465	4064	9473	5005	11481	5946	13429
16	800	2586	5780	3460	7921	4335	10063	5339	12205	6343	14283
17	850	2748	6102	3677	8378	4606	10653	5673	12930	6739	15137
18	900	2909	6425	3893	8834	4877	11244	6006	13654	7136	15991
19	950	3071	6747	4109	9291	5148	11834	6340	14378	7532	16845
20	1000	3233	7070	4326	9747	5419	12424	6674	15102	7928	17699
21	1050	3394	7392	4542	10203	5690	13014	7007	15826	8325	18553
22	1100	3556	7715	4758	10660	5960	13605	7341	16550	8721	19407
23	1150	3717	8037	4974	11116	6231	14195	7675	17274	9118	20261
24	1200	3879	8360	5191	11573	6502	14785	8008	17999	9514	21115
25	1250	4041	8683	5407	12029	6773	15375	8342	18723	9911	21969

Ceny nie zawierają zamocowań. **Niebieskie ceny:** dostawa możliwa w jednym bloku.

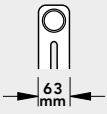
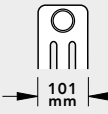
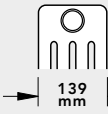
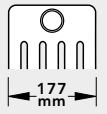
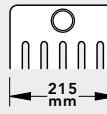
wysokość [mm] 2500		2-kolumnowy		3-kolumnowy		4-kolumnowy		5-kolumnowy		6-kolumnowy	
rozstaw króćców 2435 mm											
typ		2250		3250		4250		5250		6250	
wykładnik n		1,3398		1,3393		1,3387		1,3312		1,3236	
poj. wody/człon w l		2,34		3,39		4,45		5,50		6,55	
waga/człon w kg		3,89		5,75		7,63		9,49		11,37	
człony	długość [mm]	[W]	PLN	[W]	PLN	[W]	PLN	[W]	PLN	[W]	PLN
4	200	737	2071	982	2688	1227	3280	1509	3873	1791	4497
5	250	921	2434	1227	3205	1533	3946	1886	4686	2239	5467
6	300	1105	2797	1473	3722	1840	4611	2263	5499	2687	6437
7	350	1290	3160	1718	4240	2146	5276	2640	6313	3134	7406
8	400	1474	3524	1964	4757	2453	5941	3018	7126	3582	8376
9	450	1658	3887	2209	5274	2760	6607	3395	7939	4030	9345
10	500	1842	4250	2454	5791	3066	7272	3772	8753	4478	10315
11	550	2027	4613	2700	6309	3373	7937	4149	9566	4926	11285
12	600	2211	4976	2945	6826	3680	8603	4527	10380	5373	12254
13	650	2395	5339	3191	7343	3986	9268	4904	11193	5821	13224
14	700	2579	5702	3436	7860	4293	9933	5281	12006	6269	14193
15	750	2763	6065	3682	8377	4600	10599	5658	12820	6717	15163
16	800	2948	6428	3927	8895	4906	11264	6035	13633	7164	16133
17	850	3132	6791	4172	9412	5213	11929	6413	14446	7612	17102
18	900	3316	7154	4418	9929	5520	12594	6790	15260	8060	18072
19	950	3500	7517	4663	10446	5826	13260	7167	16073	8508	19041
20	1000	3685	7880	4909	10964	6133	13925	7544	16887	8956	20011
21	1050	3869	8243	5154	11481	6439	14590	7921	17700	9403	20981
22	1100	4053	8607	5400	11998	6746	15256	8299	18513	9851	21950
23	1150	4237	8970	5645	12515	7053	15921	8676	19327	10299	22920
24	1200	4422	9333	5891	13033	7359	16586	9053	20140	10747	23889
25	1250	4606	9696	6136	13550	7666	17252	9430	20954	11195	24859

Product Class
D13000Item Group
00D90CETIM Class
EC003539

dane techniczne / ceny netto

Ceny nie zawierają zamocowań. **Niebieskie ceny** dostawa możliwa w jednym bloku.

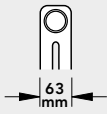
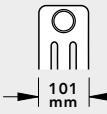
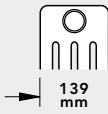
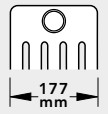
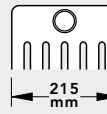
wysokość [mm]		2-kolumnowy		3-kolumnowy		4-kolumnowy		5-kolumnowy		6-kolumnowy	
2800											
rozstaw króćców 2735 mm		63 mm		101 mm		139 mm		177 mm		215 mm	
typ		2280		3280		4280		5280		6280	
wykładnik n		1,3354		1,3307		1,3260		1,3131		1,3002	
poj. wody/człton w l		2,61		3,78		4,95		6,12		7,29	
waga/człton w kg		4,34		6,43		8,53		10,61		12,71	
człtony	długość [mm]	[W]	PLN	[W]	PLN	[W]	PLN	[W]	PLN	[W]	PLN
4	200	829	2209	1100	2940	1371	3629	1685	4230	1998	4968
5	250	1037	2607	1375	3520	1714	4382	2106	5132	2498	6055
6	300	1244	3004	1651	4100	2057	5134	2527	6035	2997	7142
7	350	1452	3402	1926	4680	2400	5887	2948	6938	3497	8230
8	400	1659	3799	2201	5260	2743	6639	3369	7840	3996	9317
9	450	1866	4197	2476	5840	3085	7392	3791	8743	4496	10404
10	500	2074	4595	2751	6420	3428	8144	4212	9646	4995	11491
11	550	2281	4992	3026	7001	3771	8897	4633	10548	5495	12578
12	600	2488	5390	3301	7581	4114	9649	5054	11451	5994	13666
13	650	2696	5787	3576	8161	4457	10402	5475	12354	6494	14753
14	700	2903	6185	3851	8741	4799	11154	5897	13256	6993	15840
15	750	3110	6582	4126	9321	5142	11907	6318	14159	7493	16927
16	800	3318	6980	4401	9901	5485	12659	6739	15062	7992	18015
17	850	3525	7378	4677	10481	5828	13412	7160	15964	8492	19102
18	900	3732	7775	4952	11062	6171	14165	7581	16867	8992	20189
19	950	3940	8173	5227	11642	6514	14917	8002	17770	9491	21276
20	1000	4147	8570	5502	12222	6856	15670	8424	18672	9991	22363
21	1050	4355	8968	5777	12802	7199	16422	8845	19575	10490	23451
22	1100	4562	9365	6052	13382	7542	17175	9266	20478	10990	24538
23	1150	4769	9763	6327	13962	7885	17927	9687	21380	11489	25625
24	1200	4977	10160	6602	14542	8228	18680	10108	22283	11989	26712
25	1250	5184	10558	6877	15123	8571	19432	10530	23186	12488	27800

Ceny nie zawierają zamocowań. **Niebieskie ceny** dostawa możliwa w jednym bloku.

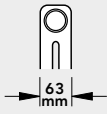
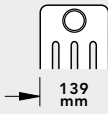
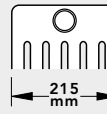
wysokość [mm]		2-kolumnowy		3-kolumnowy		4-kolumnowy		5-kolumnowy		6-kolumnowy	
3000											
rozstaw króćców 2935 mm		63 mm		101 mm		139 mm		177 mm		215 mm	
typ		2300		3300		4300		5300		6300	
wykładnik n		1,3267		1,3218		1,3169		1,2985		1,2800	
poj. wody/człton w l		2,79		4,03		5,29		6,53		7,79	
waga/człton w kg		4,65		6,88		9,12		11,35		13,60	
człtony	długość [mm]	[W]	PLN	[W]	PLN	[W]	PLN	[W]	PLN	[W]	PLN
4	200	892	2299	1181	3118	1469	3816	1803	4489	2137	5236
5	250	1116	2718	1476	3743	1836	4615	2254	5457	2672	6390
6	300	1339	3138	1771	4368	2204	5414	2705	6424	3206	7544
7	350	1562	3558	2066	4992	2571	6213	3155	7392	3740	8698
8	400	1785	3978	2361	5617	2938	7013	3606	8359	4274	9852
9	450	2008	4398	2657	6242	3305	7812	4057	9327	4809	11006
10	500	2231	4818	2952	6867	3673	8611	4508	10294	5343	12160
11	550	2454	5238	3247	7491	4040	9410	4959	11262	5877	13315
12	600	2677	5658	3542	8116	4407	10209	5409	12229	6412	14469
13	650	2900	6077	3837	8741	4774	11009	5860	13197	6946	15623
14	700	3123	6497	4133	9366	5142	11808	6311	14165	7480	16777
15	750	3347	6917	4428	9990	5509	12607	6762	15132	8015	17931
16	800	3570	7337	4723	10615	5876	13406	7212	16100	8549	19085
17	850	3793	7757	5018	11240	6243	14205	7663	17067	9083	20239
18	900	4016	8177	5313	11865	6611	15005	8114	18035	9617	21394
19	950	4239	8597	5608	12489	6978	15804	8565	19002	10152	22548
20	1000	4462	9017	5904	13114	7345	16603	9016	19970	10686	23702
21	1050	4685	9436	6199	13739	7712	17402	9466	20937	11220	24856
22	1100	4908	9856	6494	14364	8080	18201	9917	21905	11755	26010
23	1150	5131	10276	6789	14988	8447	19001	10368	22872	12289	27164
24	1200	5354	10696	7084	15613	8814	19800	10819	23840	12823	28318
25	1250	5578	11116	7380	16238	9181	20599	11270	24808	13358	29473

LASERLINE TWIN



wysokość
1000, 1200, 1500
i 1800 mm



długość
500 mm (10 członów)
600 mm (12 członów)



głębokość
2-kolumnowy: 63 mm



podłączenia
2 x GW 1/2" dolne, środkowe, odstęp 50 mm
1 x GW 1/2" na dole po prawej stronie dla grzałki elektrycznej
zawór odpowietrzający 1/2" u góry z prawej strony z boku



maks. ciśnienie robocze
10 bar



maks. temperatura pracy
110 °C

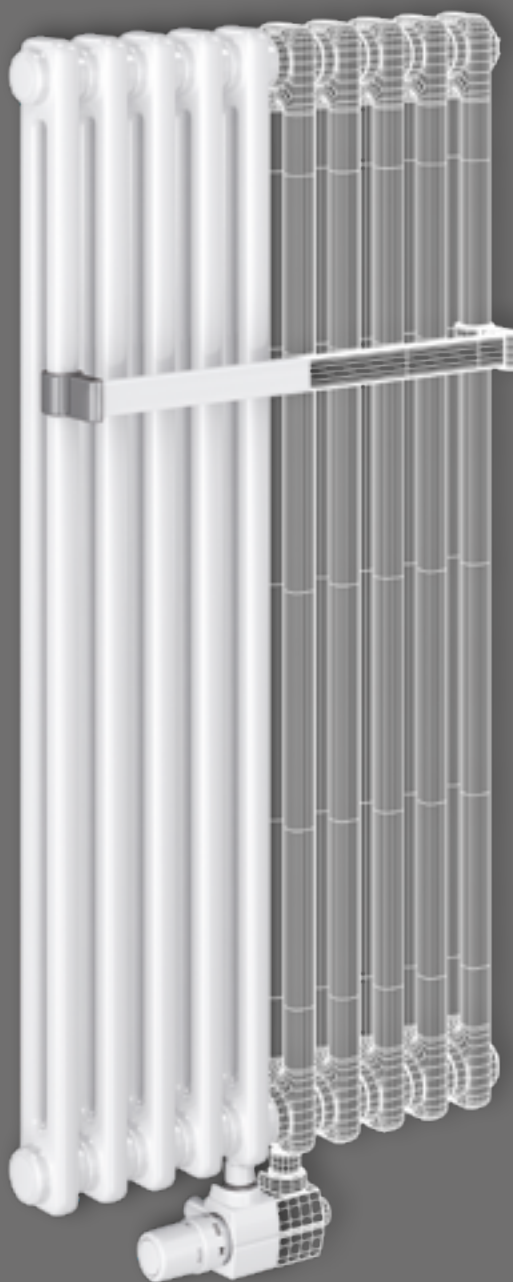

- spawany laserowo - niewidoczne połączenia zgrzewane
- wysoka precyzja produkcji
- optymalne wykonanie ułatwiające czyszczenie
- z zamocowaniem i wieszakiem

Grzejniki dekoracyjne kolumnowe z kompletnym spawaniem laserowym, rury i głowice spłaszczone na stronach zewnętrznych dla podwyższenia mocy cieplnej.

Mocowanie

Z tyłu grzejnika przyspawane są zawieszki.

Zakres dostawy

Dostawa łącznie z zawieszkami, konsolami ściennymi, śrubami mocującymi i kołkami; włącznie z regulowanym, ruchomym w pionie wieszakiem w kolorze grzejnika z chromowanym uchwytem.

Powłoka

Według DIN 55 900, z elektroforetycznym gruntowaniem i pokryte wypalnym proszkiem w kolorze śnieżnobiałym RAL 9016, inne kolory z palety RAL i kolory specjalne na zapytanie.

Bezpieczeństwo

Konstrukcja odpowiada wymaganiom BHP zgodnie z wytycznymi ustawowego ubezpieczyciela od wypadków (GUV).

Opakowanie

Nieszkodliwe dla środowiska opakowanie transportowe z kartonową osłoną krańdździ, zgrzewane w folii.

Podłączenie

Grzejnik LaserLine Twin jest podłączony od dołu po środku przez 2 przyłącza 1/2". Przyłącze zasilania znajduje się zawsze po lewej stronie, przyłącze powrotu po prawej stronie. Rozstaw przyłącza wynosi 50 mm.

Uwaga!

Tolerancja długości dostarczanych grzejników wynosi 0 do +1 %. Uwzględnić to przy montażu wstępnym!

Product Class
D14000Item Group
00D91EETIM Class
EC003539

dane techniczne / ceny netto

		wysokość [mm]	1000	1200	1500	1800	2000
			2-kolumnowy 	2-kolumnowy 	2-kolumnowy 	2-kolumnowy 	2-kolumnowy 
		typ	2100	2120	2150	2180	2200
człony	długość [mm]						
10	500	[W] 75/65/20° *	753	894	1106	1322	1468
		pojemność wody w l	10,20	11,90	14,60	17,20	19,00
		waga w kg	15,90	19,00	23,60	28,20	31,20
		wykładnik n	1,2684	1,2823	1,3023	1,3197	1,3289
		ceny PLN	5210	5523	6109	6554	6928
12	600	[W] 75/65/20° *	903	1072	1328	1587	1762
		pojemność wody w l	12,20	14,30	17,50	20,60	22,80
		waga w kg	19,10	22,80	28,30	33,80	37,40
		wykładnik n	1,2684	1,2823	1,3023	1,3197	1,3289
		ceny PLN	5584	5951	6659	7160	7489

* Moc cieplna grzejników [W] wg normy EN 442. PKWiU 25.21.11.0; CN 2020 7322 1900.

specjalne wykonanie

opłaty dodatkowe za specjalne wykonanie	dopłata
PTC - grzałka elektryczna z uziemieniem 750W AZ13EH0048002730	1220 PLN
PTC - grzałka elektryczna z uziemieniem 900W (nie jest odpowiednia dla modelu 2100/10 członów) AZ13EH0048002930	1249 PLN

Ceny netto w zł bez podatku VAT.

przeгляд typów

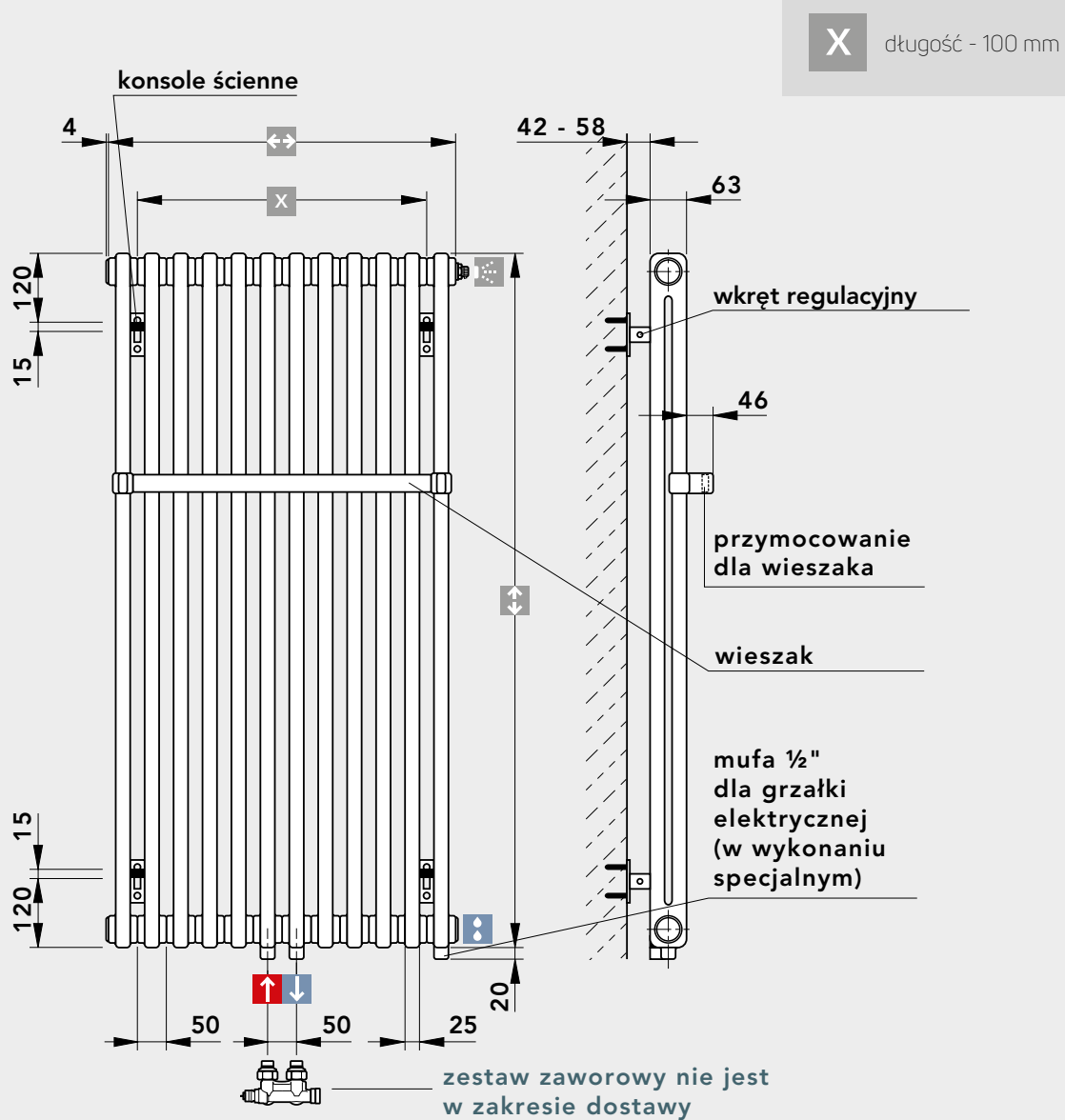

LASERLINE THEKE

**wysokość**940 (750) mm lub
1090 (900) mm

(wys. grzejnika podane są w nawiasach)

**długość**720 (700) mm, 920 (900) mm
lub 1120 (1100) mm (dług. grzejnika podane są w nawiasach)**głębokość**4-kolumnowy 224 mm
5-kolumnowy 262 mm**podłączenia**

zasilanie z lewej strony od dołu, gwint wewnętrzny G1/2", powrót z prawej strony od dołu, gwint wewnętrzny G 1/2"; fabrycznie zamontowana wkładka zaworowa z nastawą wstępną wraz z głowicą termostatyczną z gwintem przyłączeniowym M 30*1,5 mm z lewej strony u góry, zawór odpowietrzający G 1/2" z prawej strony u góry.

**maks. ciśnienie robocze**

10 bar

**maks. temperatura pracy**

110 °C

- spawany laserowo - niewidoczne połączenia zgrzewane
- wysoka precyzja produkcji
- optymalne wykonanie ułatwiające czyszczenie
- unikalne możliwości użytkowe



Dekoracyjny grzejnik kolumnowy w formie bufetu, kompletnie spawany, rury i głowice na zewnętrznych stronach spłaszczone dla podwyższenia mocy cieplnej;

Króciec przyłączowy 1"; długość członu 50 mm, zestaw dekoracyjny

Mocowanie

Zestaw dekoracyjny do prostego i trwałego montażu i do osłonięcia podłączeń z możliwością zamocowania pokrywy bukowej u klienta.

Zakres dostawy

Dostawa z konsolami i zestawem dekoracyjnym, bez pokrywy bukowej, z głowicą termostatyczną (Oventrop Uni LH)

Powłoka

Według DIN 55 900, z elektroforetycznym gruntowaniem i pokryte wypalonym proszkiem w kolorze śnieżnobiałym RAL 9016, inne kolory z palety RAL i kolory specjalne na zapytanie.

Bezpieczeństwo

Konstrukcja odpowiada wymaganiom BHP zgodnie z wytycznymi ustawowego ubezpieczyciela od wypadków (GUV).

Opakowanie

Nieszkodliwe dla środowiska opakowanie transportowe z kartonową osłoną krańdździ, zgrzewane w folii.





Uwaga!

Tolerancja długości dostarczanych grzejników wynosi 0 do + 1%. Uwzględnić to przy montażu wstępnym.

68 LASERLINE THEKE

Przeгляд typów, ceny i wydajność cieplna

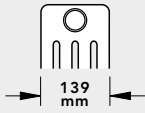
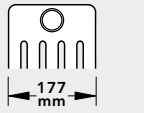
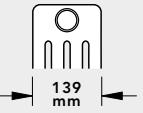
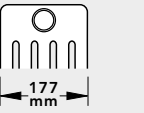
Product Class D15A00 Item Group 00D95A ETIM Class EC003539

dane techniczne / ceny netto			940		1090	
 wysokość Theke [mm]			940		1090	
wysokość grzejnika [mm]			750		900	
 głębokość Theke [mm]			224	262	224	262
głębokość grzejnika			4-kolumnowy  139 mm	5-kolumnowy  177 mm	4-kolumnowy  139 mm	5-kolumnowy  177 mm
typ			4075	5075	4090	5090
człony	 długość [mm]					
14	720 (700)*	[W] 75/65/20° **	1416	1747	1665	2055
		pojemność wody w l	21,2	26,1	24,7	30,4
		waga w kg	50	58	58	68
		wykładnik n	1,2986	1,2997	1,3147	1,3139
		ceny PLN	8535	8950	8853	9344
18	920 (900)*	[W] 75/65/20° **	1821	2246	2141	2642
		pojemność wody w l	27,2	33,5	31,7	39,1
		waga w kg	59	70	69	82
		wykładnik n	1,2986	1,2997	1,3147	1,3139
		ceny PLN	9245	9773	9659	10284
22	1120 (1100)*	[W] 75/65/20° **	2225	2746	2616	3229
		pojemność wody w l	33,3	41,0	38,8	47,8
		waga w kg	69	82	81	97
		wykładnik n	1,2986	1,2997	1,3147	1,3139
		ceny PLN	9951	10593	10465	11224

* długość grzejnika
** Moc cieplna grzejników [W] wg normy EN 442. PKWiU 25.21.11.0; CN 2020 7322 1900.

Product Class A1D000 Item Group 00AZB0 ETIM Class EC010858

pokrywa bukowa dla Theke	wymiary pokrywy	dla typu	numer artykułu	waga w kg	ceny w PLN
	1150 x 350 x 35	4075 i 4090 dł 700 mm	AZ13DZ8340901400	~9	6692
	1350 x 350 x 35	4075 i 4090 dł 900 mm	AZ13DZ8340901800	~10	6855
	1550 x 350 x 35	4075 i 4090 dł 1100 mm	AZ13DZ8340902200	~11	7026
	1150 x 400 x 35	5075 i 5090 dł 700 mm	AZ13DZ8350901400	~10	7047
	1350 x 400 x 35	5075 i 5090 dł 900 mm	AZ13DZ8350901800	~11	7249
	1550 x 400 x 35	5075 i 5090 dł 1100 mm	AZ13DZ8350902200	~12	7443

Ceny netto w zł bez podatku VAT.

przeгляд typów

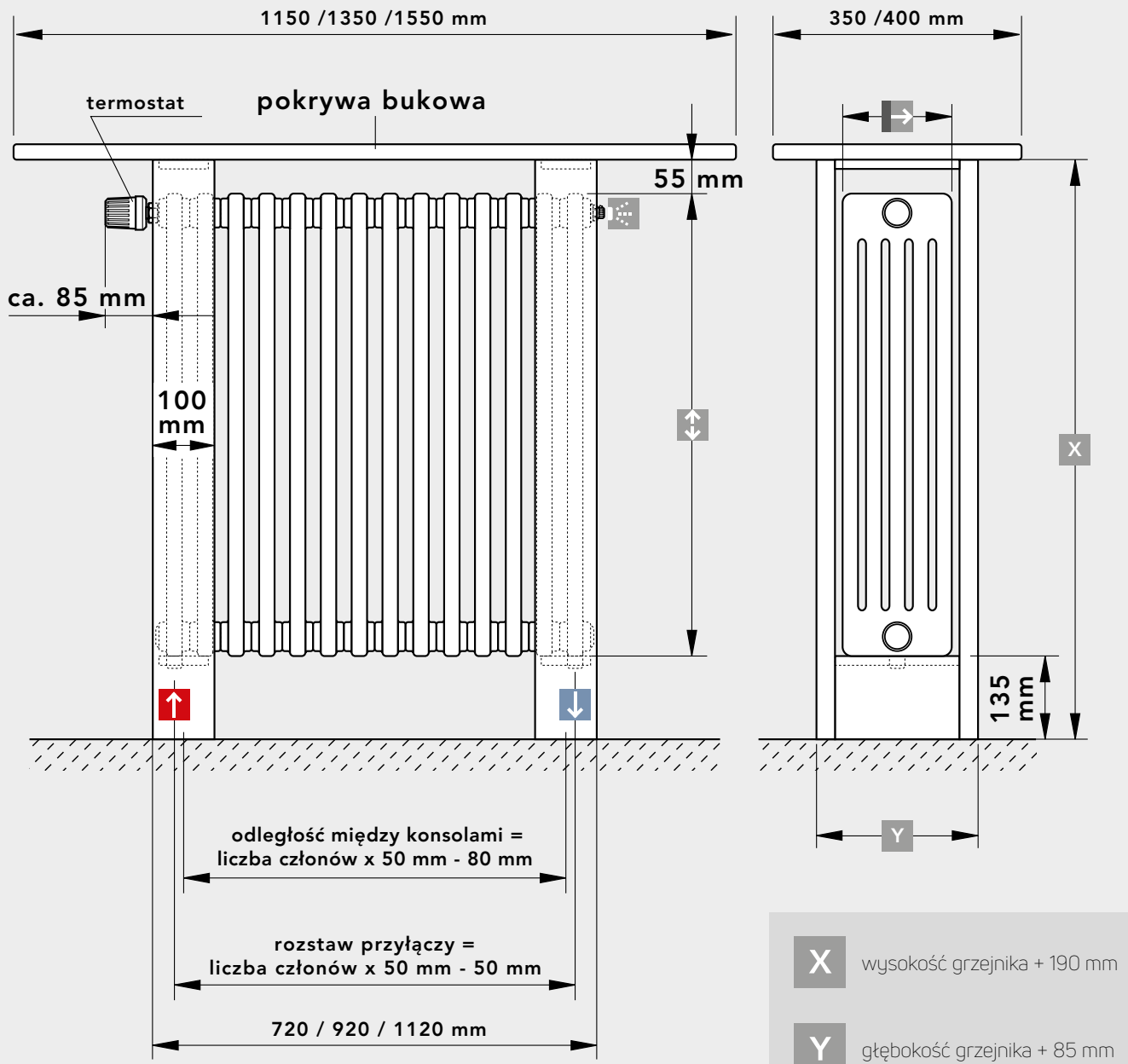

LASERLINE BANK



wysokość
422 mm (4 członowy),
472 mm (5 członowy),
522 mm (6 członowy),
572 mm (7 członowy)



długość
1850 do 3150 mm



głębokość
370 mm

**podłączenia**

Zasilanie z lewej strony u dołu, gwint wewnętrzny G 1/2", powrót z prawej strony od dołu, gwint wewnętrzny G 1/2"; z zaworem termostatycznym z nastawą wstępną wraz z głowicą termostatyczną z gwintem przyłączeniowym M 30*1,5 mm z lewej strony u dołu, odpowietrznik z gwintem G 1/2" z prawej strony u góry.



maks. ciśnienie robocze
10 bar



maks. temperatura pracy
110 °C

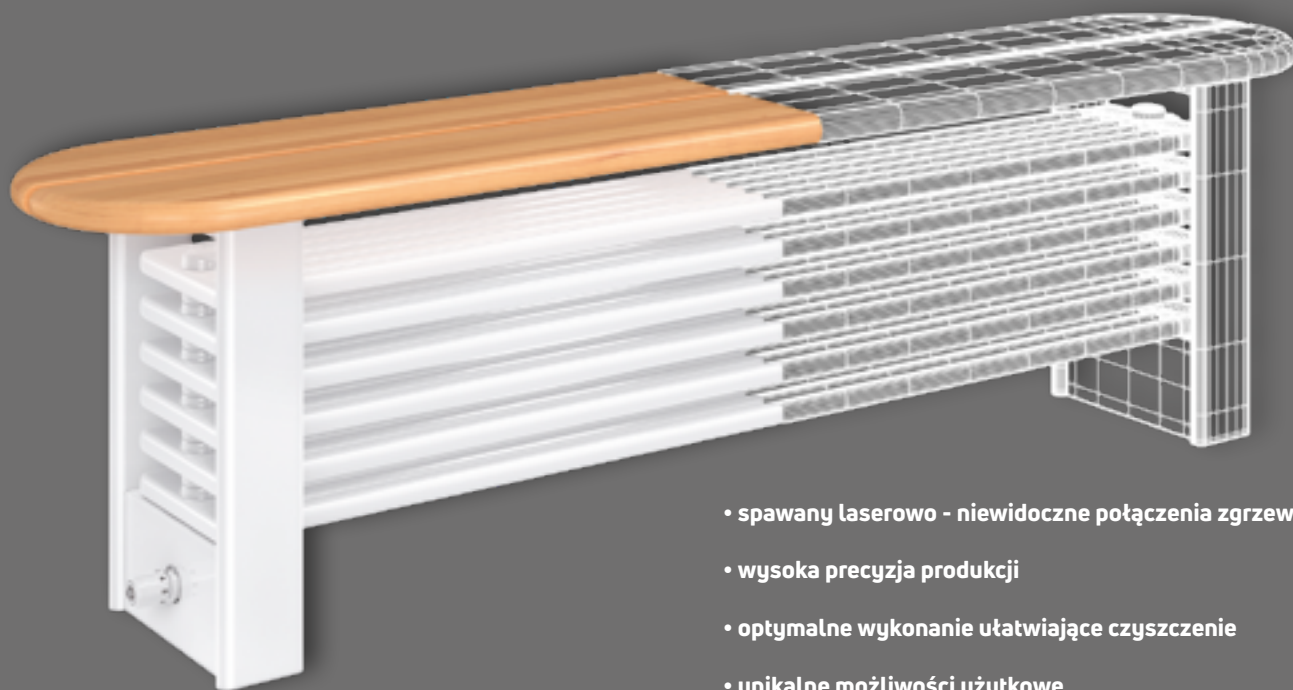

- spawany laserowo - niewidoczne połączenia zgrzewane
- wysoka precyzja produkcji
- optymalne wykonanie ułatwiające czyszczenie
- unikalne możliwości użytkowe

Dekoracyjny grzejnik kolumnowy w formie ławki, kompletnie spawany, rury i głowice na zewnętrznych stronach spłaszczone dla podwyższenia mocy cieplnej;

Króciec przyłączowy 1"; długość członu 50 mm, 4 do 7 członów leżących jeden na drugim

Mocowanie

Zestaw dekoracyjny do prostego i trwałego montażu i do osłonięcia podłączeń z możliwością zamocowania pokrywy bukowej u klienta.

Zakres dostawy

Dostawa z konsolami i zestawem dekoracyjnym, bez pokrywy bukowej, z głowicą termostatyczną (Oventrop Uni DH)

Powłoka

Według DIN 55 900, z elektroforetycznym gruntowaniem i pokryte wypalonym proszkiem w kolorze śnieżnobiałym RAL 9016, inne kolory z palety RAL i kolory specjalne na zapytanie.

Bezpieczeństwo

Konstrukcja odpowiada wymaganiom BHP zgodnie z wytycznymi ustawowego ubezpieczyciela od wypadków (GUV).

Opakowanie

Nieszkodliwe dla środowiska opakowanie transportowe z kartonową osłoną krawedzi, zgrzewane w folii.

Uwaga!

Tolerancja długości dostarczanych grzejników wynosi 0 do +1%. Uwzględnić to przy montażu wstępnym.

Product Class D15000	Item Group 00D92A	ETIM Class EC003539
-------------------------	----------------------	------------------------

dane techniczne / ceny netto

			1850	2150	2350	2850	3150
↔		długość Bank [mm]					
		długość grzejnika [mm]	1500	1800	2000	2500	2800
→		głębokość Bank [mm]	370				
		głębokość grzejnika	<p style="text-align: center;">6-kolumnowy</p> 				
typ			6150	6180	6200	6250	6280
człony	↕ wysokość [mm]						
4	422 (200)*	[W] 75/65/20° **	1411	1696	1886	2362	2648
		pojemność wody w l	16,4	19,3	21,3	26,2	29,2
		waga w kg	37,5	42,8	46,4	55,3	64,2
		wykładnik n	1,3156	1,3103	1,3067	1,2978	1,2925
		ceny PLN	6525	6925	7190	9418	9807
5	472 (250)*	[W] 75/65/20° **	1742	2097	2334	2929	3287
		pojemność wody w l	20,4	24,1	26,6	32,8	36,5
		waga w kg	45,2	51,9	56,4	67,5	78,6
		wykładnik n	1,2755	1,2789	1,2801	1,2867	1,2901
		ceny PLN	7078	7587	7913	10309	10794
6	522 (300)*	[W] 75/65/20° **	1934	2337	2606	3285	3695
		pojemność wody w l	24,5	29,0	31,9	39,3	43,8
		waga w kg	52,9	60,9	66,3	79,6	93
		wykładnik n	1,2864	1,2847	1,2835	1,2806	1,2789
		ceny PLN	7631	8237	8635	11201	11779
7	572 (350)*	[W] 75/65/20° **	2204	2670	2982	3770	4247
		pojemność wody w l	28,6	33,8	37,2	45,9	51,1
		waga w kg	60,6	70,0	76,3	91,8	107,4
		wykładnik n	1,2863	1,2940	1,2992	1,3121	1,3198
		ceny PLN	8186	8888	9353	12086	12760

* wysokość grzejnika

** Moc cieplna grzejników [W] wg normy EN 442 PKWiU 25.21.11.0; CN 2020 7322 1900.

Product Class A1D000	Item Group 00AZB0	ETIM Class EC010858
-------------------------	----------------------	------------------------

pokrywa bukowa	5233	5252	5357	5548	5835
numer artykułu	AZ13DZ8361500000	AZ13DZ8361800000	AZ13DZ8362000000	AZ13DZ8362500000	AZ13DZ8362800000
waga w kg	~23	~26	~29	~34	~38

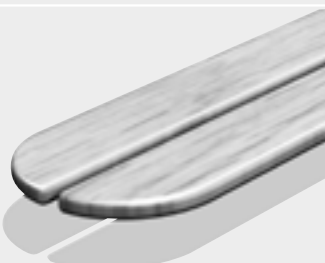

Pokrywa bukowa dla Bank

- z drewna bukowego (multipleks) około 35 mm gruba
- ze wszystkich stron zaokrąglona, dwuczęściowa, od długości 2850 mm czteroczęściowa
- powłoka lakierowana dwukrotnie lakierem bezbarwnym, jedwabnie matowa

dane techniczne

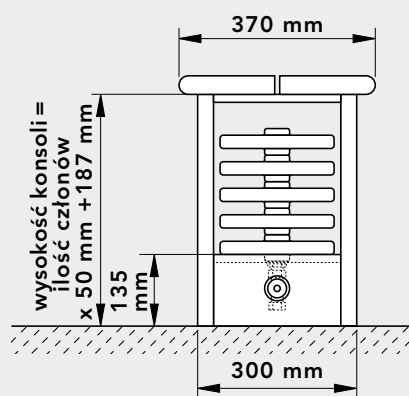
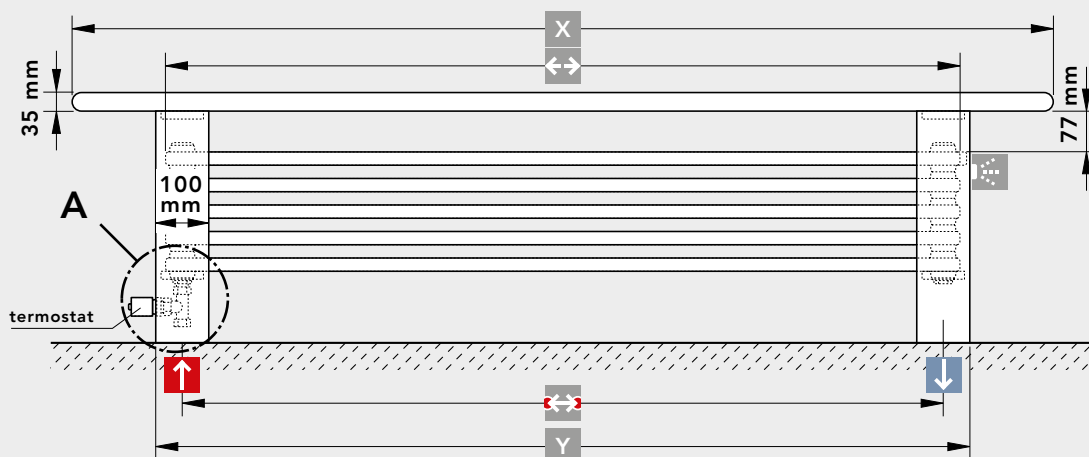

szczegół „A”

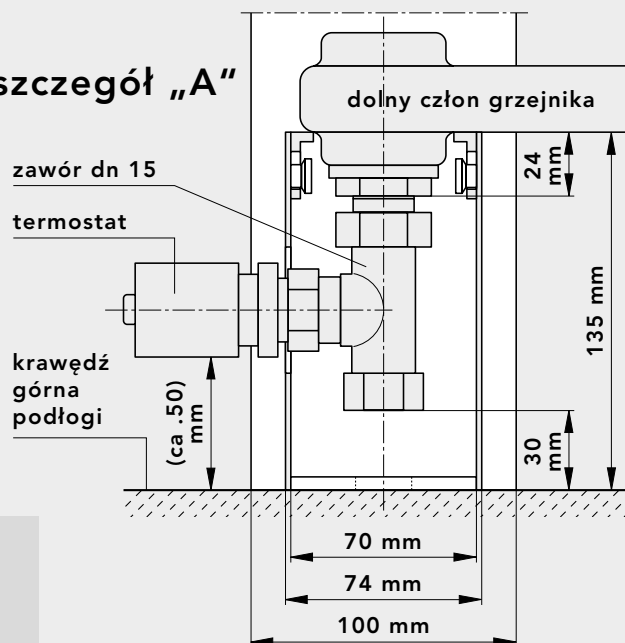

 rozstaw króćców przyłączeniowych:

X długość grzejnika + 350 mm

Y długość konsoli:
długość grzejnika + 35 mm

Uwaga: Od długości 2000 mm 3 konsole na środku

punkty zawieszenia

Mocowanie

W skład standardowego wyposażenia grzejnika kolumnowego nie wchodzi mocowanie. W zależności od typu i wielkości należy dobrać odpowiednią ilość i rodzaj zawieszenia i zamówić osobno. Jako zawieszenie standardowe do dyspozycji jest zestaw montażowy z konsolami kątowymi i zestaw montażowy z kołkami rozporowymi. Zestawy te zawierają odpowiednią liczbę konsoli, uchwytów, niezbędne śruby i kołki (każdorazowo sprawdzić ich przydatność) oraz instrukcję montażu*. Zaleca się montowanie górnych uchwytów grzejnika bezpośrednio pod górnym króćcem przyłączowym.

Na specjalne zamówienie możliwa jest dostawa wsporników wwiercanych lub wsporników ściennych w innych wariantach wykonania niż standardowe, do mocowania grzejników wyposażonych fabrycznie w przyspawane zawieszki.

Dobierając ilość zawieszek (przedstawionych na następnych stronach), należy przestrzegać liczby wymaganych punktów zawieszenia. Każdy punkt zawieszenia u góry (zalecana pozycja bezpośrednio pod króćcem przyłączowym) i każdy punkt zawieszenia u dołu tworzą pionową oś zawieszenia.

Należy każdorazowo sprawdzić nośność i stabilność ścian dla występującego obciążenia wynikającego z wielkości dobranego grzejnika.

Do montażu wolnostojących grzejników do maksymalnej wysokości 1000 mm służą konsole stojące SK2 i FK 5 (powyżej wyso-

kości 155 mm stosować wyłącznie z konsolami ściennymi). Na każdą oś zawieszenia zaleca się jedną konsolę stojącą. Dla nadzwyczajnych obciążeń do budynków użyteczności publicznej np. w szkołach są do dyspozycji specjalne konsole ściennie.

*Uwaga: Grzejnik o wysokości 155 mm można montować tylko za pośrednictwem konsoli ściennych WK 155 lub wsporników podłogowych FK5.

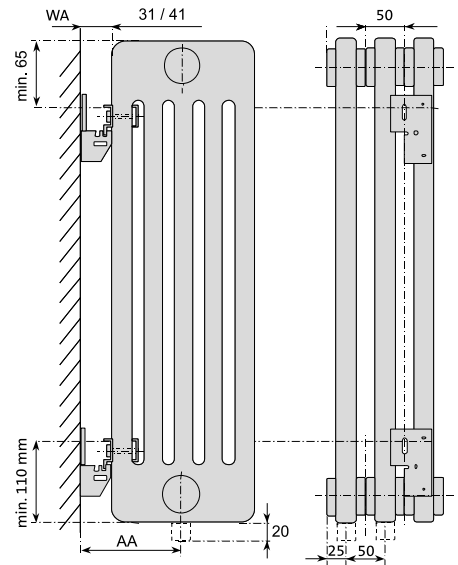

odległość montażowa dla zestawu konsoli kątowych

typ	głębokość	Odległość od ściany WA	Odległość przyłączy od ściany AA
2-kolumn.	63	31 / 41	62,5 / 72,5
3-kolumn.	101	31 / 41	81,5 / 91,5
4-kolumn.	139	31 / 41	100,5 / 110,5
5-kolumn.	177	31 / 41	119,5 / 129,5
6-kolumn.	215	31 / 41	138,5 / 148,5

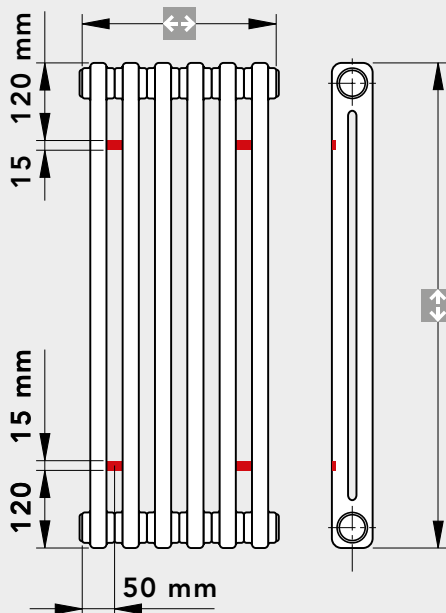

Rozkład zawieszek zewnętrznych przy 4-6 członach

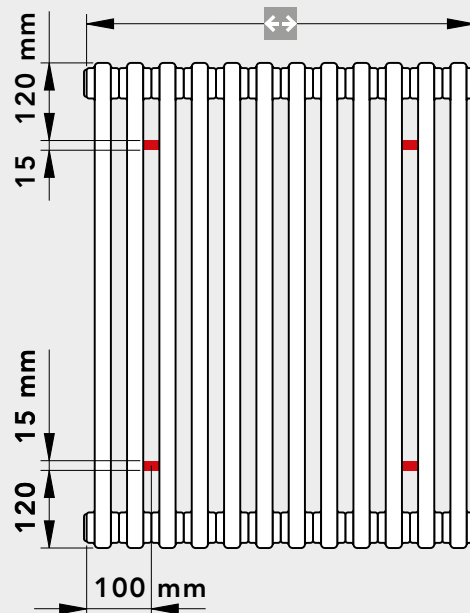

Rozkład zawieszek zewnętrznych od 7 do 20 członów.

↔ długość:
n x 50 mm

punkty zawieszenia

Grzejnik 2-kolumnowy:
maksymalne długości bloku i wymagane punkty zawieszenia

wysokość [mm]	maks. liczba członów w bloku
155	54
do 1000	42
do 2200	19
do 3000	16

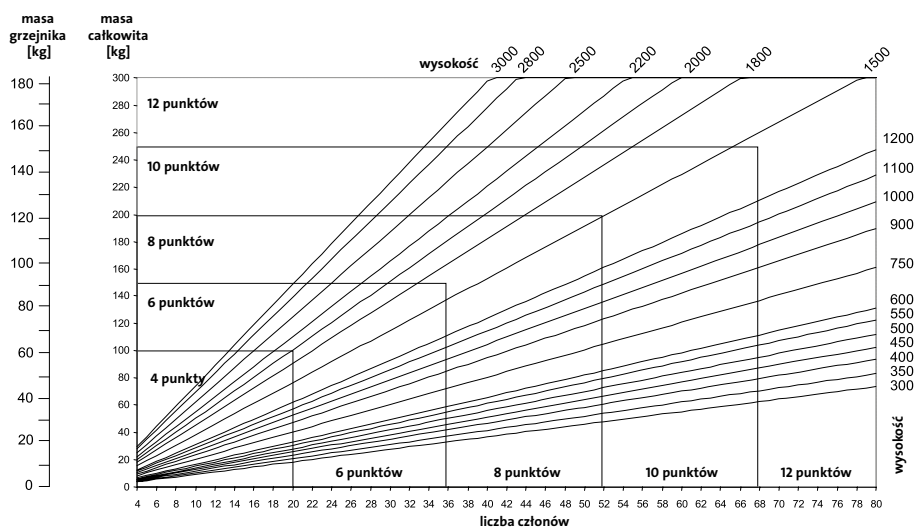

Grzejnik 3-kolumnowy:
maksymalne długości bloku i wymagane punkty zawieszenia

wysokość [mm]	maks. liczba członów w bloku
155	54
do 1000	42
do 2200	19
do 3000	16

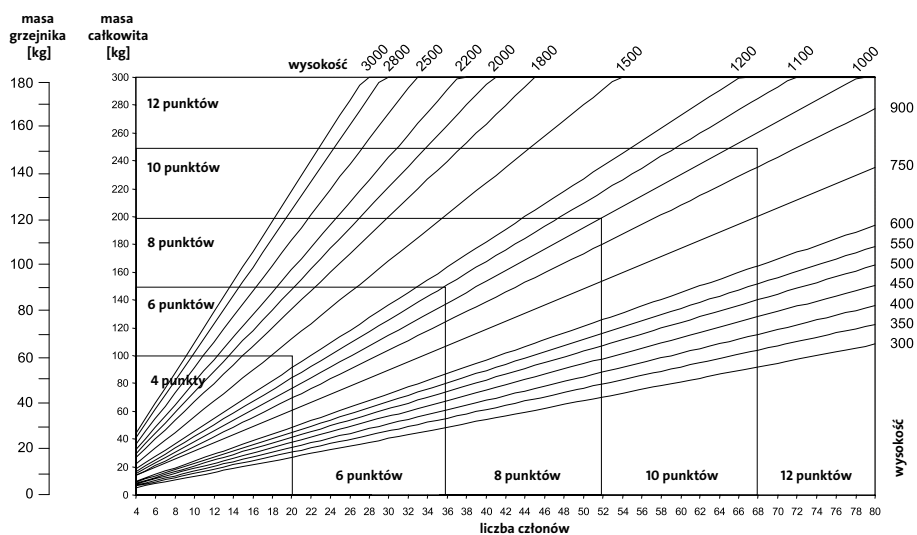

Grzejnik 4-kolumnowy:
maksymalne długości bloku i wymagane punkty zawieszenia

wysokość [mm]	maks. liczba członów w bloku
155	54
do 750	42
do 1000	32
do 1800	19
do 2000	18
do 2200	16
do 2500	14
do 2800	12
do 3000	11

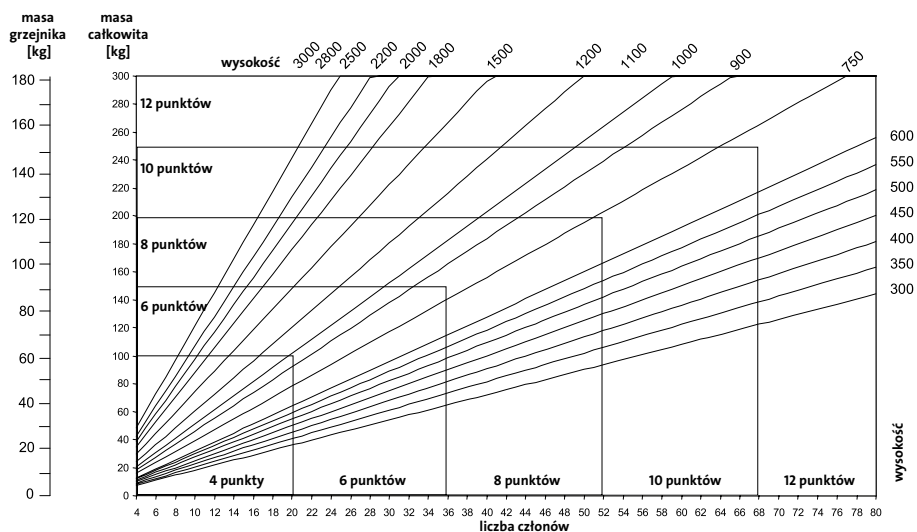

Wyznaczenie wymaganych punktów zawieszenia dla grzejników 2-, 3- i 4-kolumnowych. Każdy punkt zawieszania u góry (zalecana pozycja bezpośrednio pod króćcem przyłączowym) i każdy punkt zawieszania u dołu tworzą pionową oś zawieszania.

punkty zawieszenia

Grzejnik 5-kolumnowy:
maksymalne długości bloku i wymagane punkty zawieszenia

wysokość [mm]	maks. liczba członów w bloku
155	54
do 665	42
do 750	37
do 1000	26
do 1200	19
do 1500	18
do 1800	16
do 2000	14
do 2200	12
do 2500	11
do 2800	10
do 3000	9

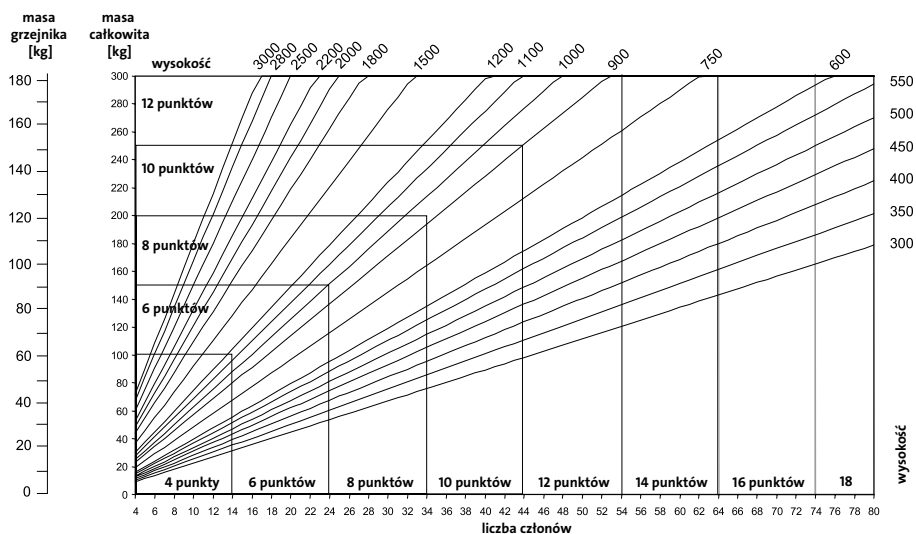

Grzejnik 6-kolumnowy:
maksymalne długości bloku i wymagane punkty zawieszenia

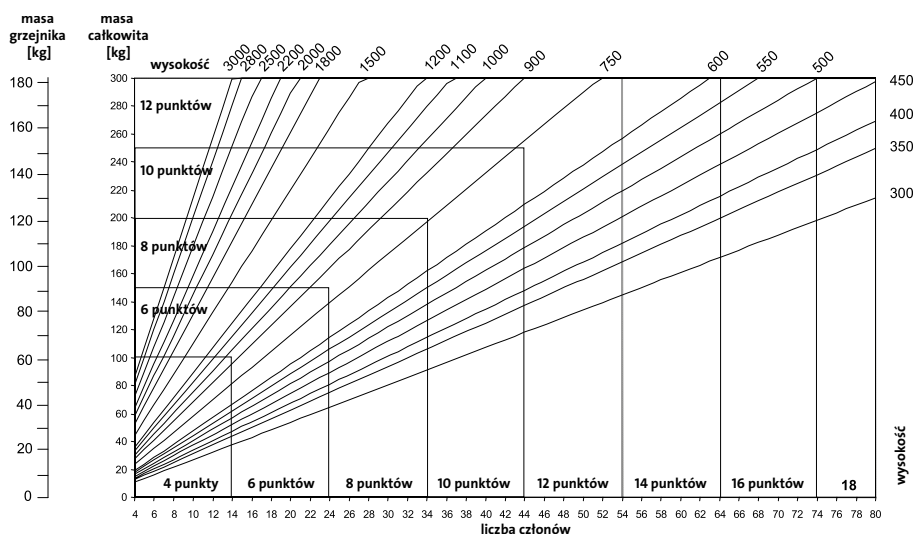

wysokość [mm]	maks. liczba członów w bloku
155	54
do 500	42
do 600	35
do 665	32
do 750	28
do 900	24
do 1000	22
do 1200	19
do 1500	15
do 1800	13
do 2000	11
do 2200	10
do 2500	9
do 3000	8





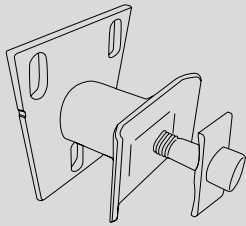

Wyznaczenie wymaganych punktów zawieszenia dla grzejników 5- i 6-kolumnowych. Każdy punkt zawieszenia u góry (zalecana pozycja bezpośrednio pod króćcem przyłączowym) i każdy punkt zawieszenia u dołu tworzą pionową oś zawieszenia.

Wskazówka:



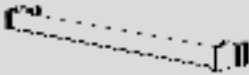

Na każdą oś zawieszenia zaleca się jeden stojak podłogowy. Dla grzejnika o wysokości 155 mm można stosować jedynie konsolę ścienną WK 155 lub stojak FK5.

akcesoria / ceny netto			
Rysunek	Opis artykułu	Nr artykułu	ceny PLN
 <p>Product Class A1D000</p> <p>Item Group 00AZB0</p> <p>ETIM Class EC010209</p>	<p>konsola stojąca FK5</p> <p>stojak podłogowy FK5 do grzejników kolumnowych o wysokości 155 mm</p> <p>dla 2 do 6 kolumnowego, regulacja 80 do 110 mm, RAL 9016 dla 2 do 6 kolumnowego, regulacja 80 do 110 mm, inny kolor dla 2 do 6 kolumnowego, regulacja 110 do 170 mm, RAL 9016 dla 2 do 6 kolumnowego, regulacja 110 do 170 mm, inny kolor dla 2 do 6 kolumnowego, regulacja 170 do 290 mm, RAL 9016 dla 2 do 6 kolumnowego, regulacja 170 do 290 mm, inny kolor</p>	<p>AZ13DZ9522724000 AZ13DZ952272700XXXX AZ13DZ9522725000 AZ13DZ952272800XXXX AZ13DZ9522723000 AZ13DZ952272600XXXX</p>	<p>za szt.</p> <p>189 230 189 230 189 230</p>
 <p>Product Class A1D000</p> <p>Item Group 00AZB0</p> <p>ETIM Class EC010858</p>	<p>Ostona stopy konsoli SK2 i FK5</p> <p>Do montażu podłogi gotowej, tworzywo sztuczne białe</p>	<p>AZ13DZ9522401000</p>	<p>za szt.</p> <p>18</p>
 <p>Product Class A1D000</p> <p>Item Group 00AZB0</p> <p>ETIM Class EC010197</p>	<p>Konsola ścienna WK 155 dla wysokości 155 mm</p> <p>Odległość od ściany 40 mm, obciążenie do 250 kg</p> <p>Grzejnik 2 kolumnowy, RAL 9016 Grzejnik 2 kolumnowy, inny kolor Grzejnik 3 kolumnowy, RAL 9016 Grzejnik 3 kolumnowy, inny kolor Grzejnik 4 kolumnowy, RAL 9016 Grzejnik 4 kolumnowy, inny kolor Grzejnik 5 kolumnowy, RAL 9016 Grzejnik 5 kolumnowy, inny kolor Grzejnik 6 kolumnowy, RAL 9016 Grzejnik 6 kolumnowy, inny kolor</p>	<p>AZ13DZ9521662000 AZ13DZ952167200XXXX AZ13DZ9521663000 AZ13DZ952167300XXXX AZ13DZ9521664000 AZ13DZ952167400XXXX AZ13DZ9521665000 AZ13DZ952167500XXXX AZ13DZ9521666000 AZ13DZ952167600XXXX</p>	<p>za szt.</p> <p>129 165 129 165 129 165 129 165 129 165</p>

akcesoria / ceny netto			
Rysunek	Opis artykułu	Nr artykułu	ceny PLN
 <p>Product Class A1D000</p> <p>Item Group 00AZB0</p> <p>ETIM Class EC002132</p>	<p>nasadka do klucza dynamometrycznego L=1000 mm, 1" dla bloków składających się z max.19 członów L=1600 mm, 1" dla bloków składających się z max. 30 członów L=2200 mm, 1" dla bloków składających się z max. 40 członów</p> <p>klucz dynamometryczny</p>	<p>AZ13DZ8810313000 AZ13DZ8810314000 AZ13DZ8810315000</p> <p>AZ13DZ8810309000</p>	<p>489 817 984</p> <p>653</p>
 <p>Product Class A1D000</p> <p>Item Group 00AZB0</p> <p>ETIM Class EC002130</p>	<p>klucz do korka zaślepiającego (tworzywo sztuczne)</p>	<p>AZ13DZ8820240000</p>	<p>100</p>
 <p>Product Class A1D000</p> <p>Item Group 00AZB0</p> <p>ETIM Class EC010858</p>	<p>wieszak wymiary 30*10 mm, 2 chromowane uchwyty, głębokość 45 mm, długość na życzenie od 300 do 1000 mm (od 6 do 20 członów) Przykład zamówienia: D881-2125 – 12 = ilość członów</p> <p>RAL 9016 inny kolor</p>	<p>AZ13DZ812125XXX0¹⁾ AZ13DZ812115XXXXXX²⁾</p>	<p>445 545</p>
 <p>Product Class A1D000</p> <p>Item Group 00AZB0</p> <p>ETIM Class EC000150</p>	<p>szczotka 3-ramienna</p>	<p>AZ13DZ8810260000</p>	<p>313</p>

¹⁾ XXX - ilość członów np. AZ13DZ8121250600 - 6 członów, AZ13DZ8121251100 - 11 członów

²⁾ XXX - ilość członów, XXXXX - kolor

akcesoria / ceny netto			
Rysunek	Opis artykułu	Nr artykułu	ceny PLN
	nypel 1" <small>Product Class: A1D000 Item Group: 00AZB0 ETIM Class: EC003024</small>	AZ13DZ8820230000	16
	uszczelka 1" <small>Product Class: A1D000 Item Group: 00AZB0 ETIM Class: EC001181</small>	AZ13DZ8820210000	11
 <small>Product Class: A1D000 Item Group: 00AZB0 ETIM Class: EC003023</small>	korek 1/2" nikielowany	AZ13DZ8810106000	15
 <small>Product Class: A1D000 Item Group: 00AZB0 ETIM Class: EC010047</small>	odpowietrznik 1/2" nikielowany	AZ13DZ8810202000	37
 <small>Product Class: A1D000 Item Group: 00AZB0 ETIM Class: -</small>	zestaw: korek 1/2" + odpowietrznik 1/2" biały	AZ13DZ8810120000	24
 <small>Product Class: A1D000 Item Group: 00AZB0 ETIM Class: EC010002</small>	wkładka zaworowa do LaserLine zaworowy	AZ13DZ8828321000	234

kody zamówieniowe

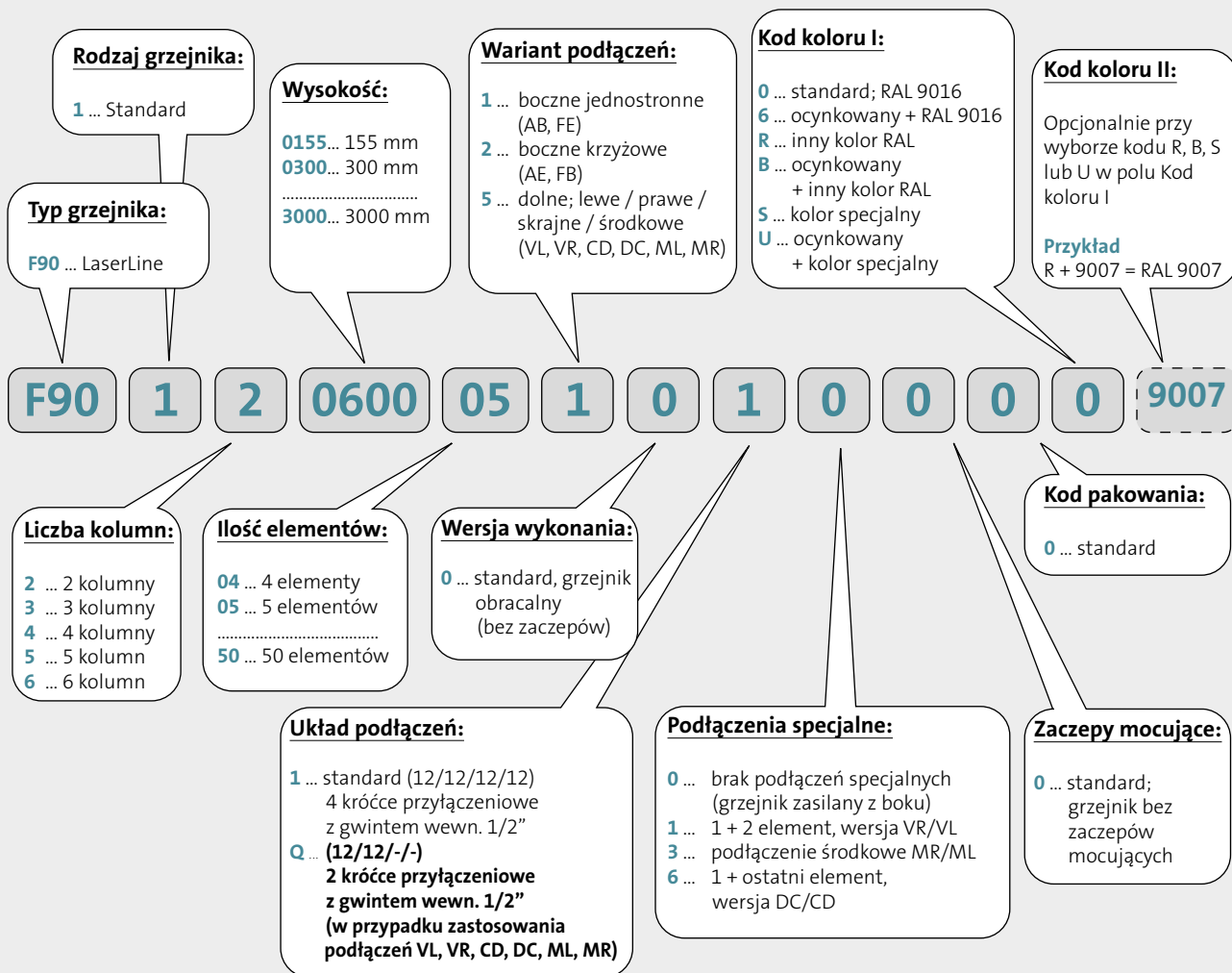

Przykładowy kod zamówienia dla grzejnika **LaserLine Standard** przedstawiono na rysunkach obok:

- typ: LaserLine Standard
- liczba kolumn: 2
- wysokość: 600 mm
- ilość elementów: 4 (długość 200 mm)
- wariant podłączeń: dolne z prawej strony
- podłączenia specjalne: wersja prawa VR
- wersja wykonania: grzejnik uniwersalny bez zaczepów mocujących
- kod pakowania: standard
- kolor: RAL 9016

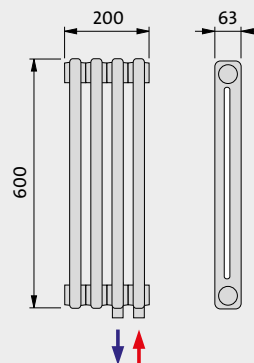

przykładowy kod zamówienia - F90120600045011000

kody zamówieniowe

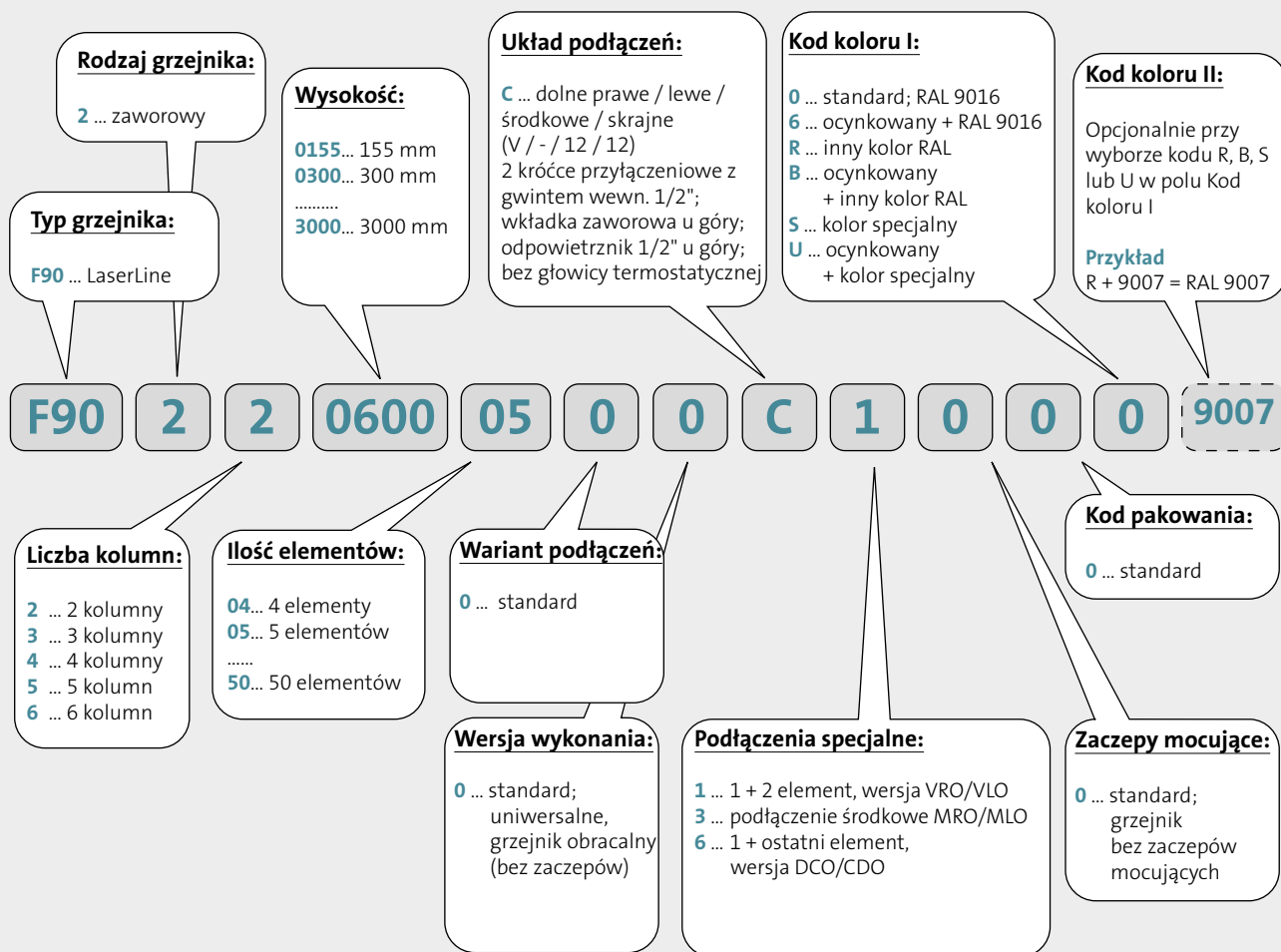

Przykładowy kod zamówienia dla grzejnika **LaserLine Zaworowy** przedstawiono na rysunkach obok:

- typ: LaserLine Zaworowy
- liczba kolumn: 2
- wysokość: 600 mm
- ilość elementów: 4 (długość 200 mm)
- wariant podłączeń: dolne z prawej strony
- podłączenia specjalne: wersja prawa VRO
- wersja wykonania: grzejnik uniwersalny bez zaczepów mocujących
- kod pakowania: standard
- kolor: RAL 9016

przykładowy kod zamówienia - F902206000400C1000

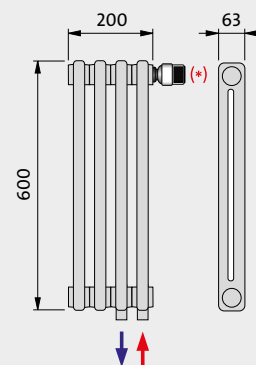

(*) Uwaga: głowica termostatyczna nie stanowi wyposażenia standardowego grzejnika LaserLine Zaworowy. Należy ją zamawiać osobno.

kody zamówieniowe

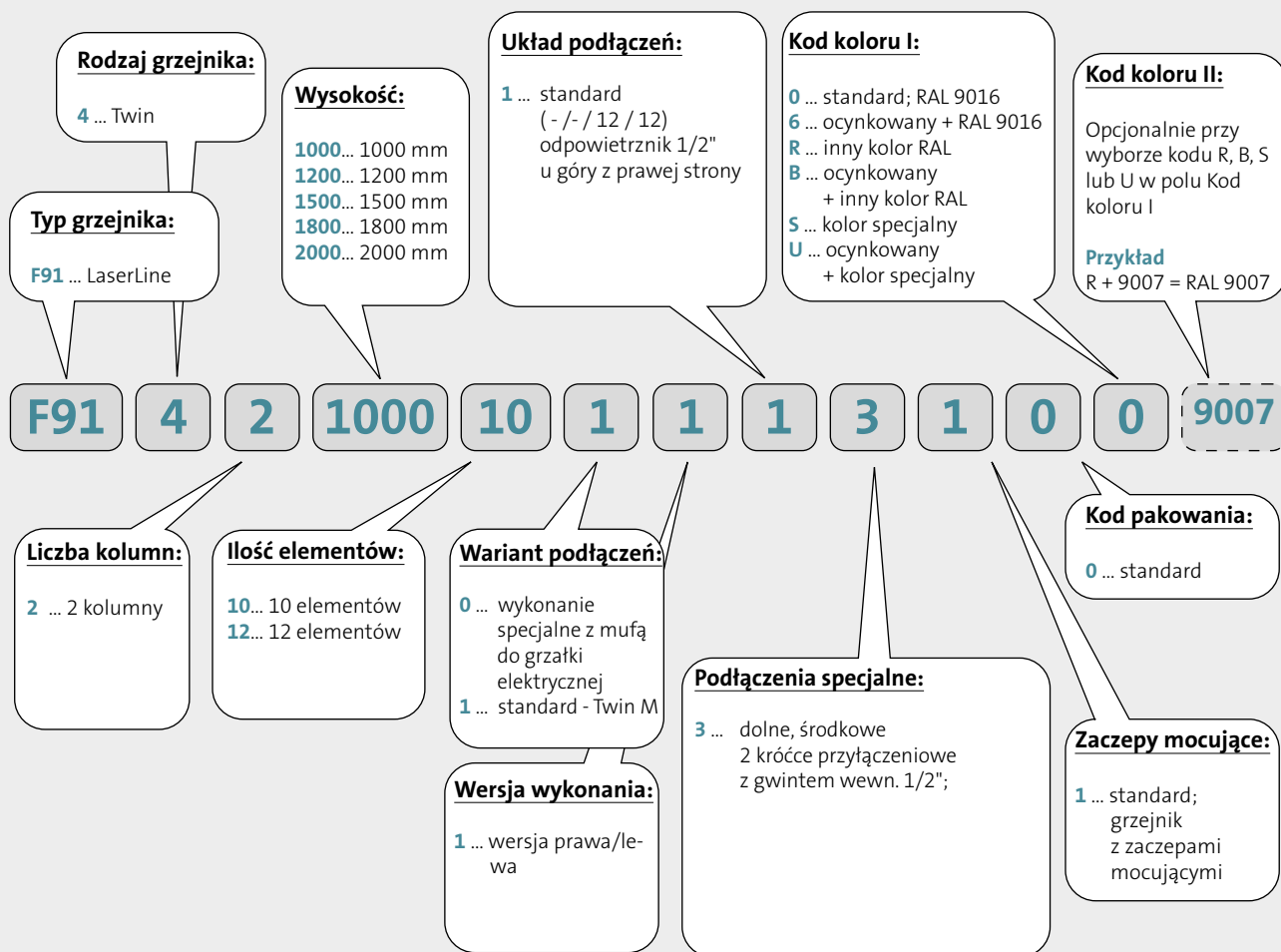

Przykładowy kod zamówienia dla grzejnika **LaserLine Twin** przedstawiony na rysunkach obok:

- typ: LaserLine Twin
- liczba kolumn: 2
- wysokość: 1000 mm
- ilość elementów: 10 (długość 500 mm)
- wariant podłączeń: środkowe
- wersja wykonania: z zaczeptami mocującymi
- kod pakowania: standard
- kolor: RAL 9016

przykładowy kod zamówienia - F91421000101113100

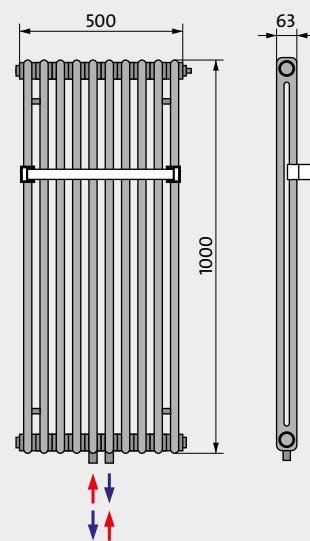

kody zamówieniowe

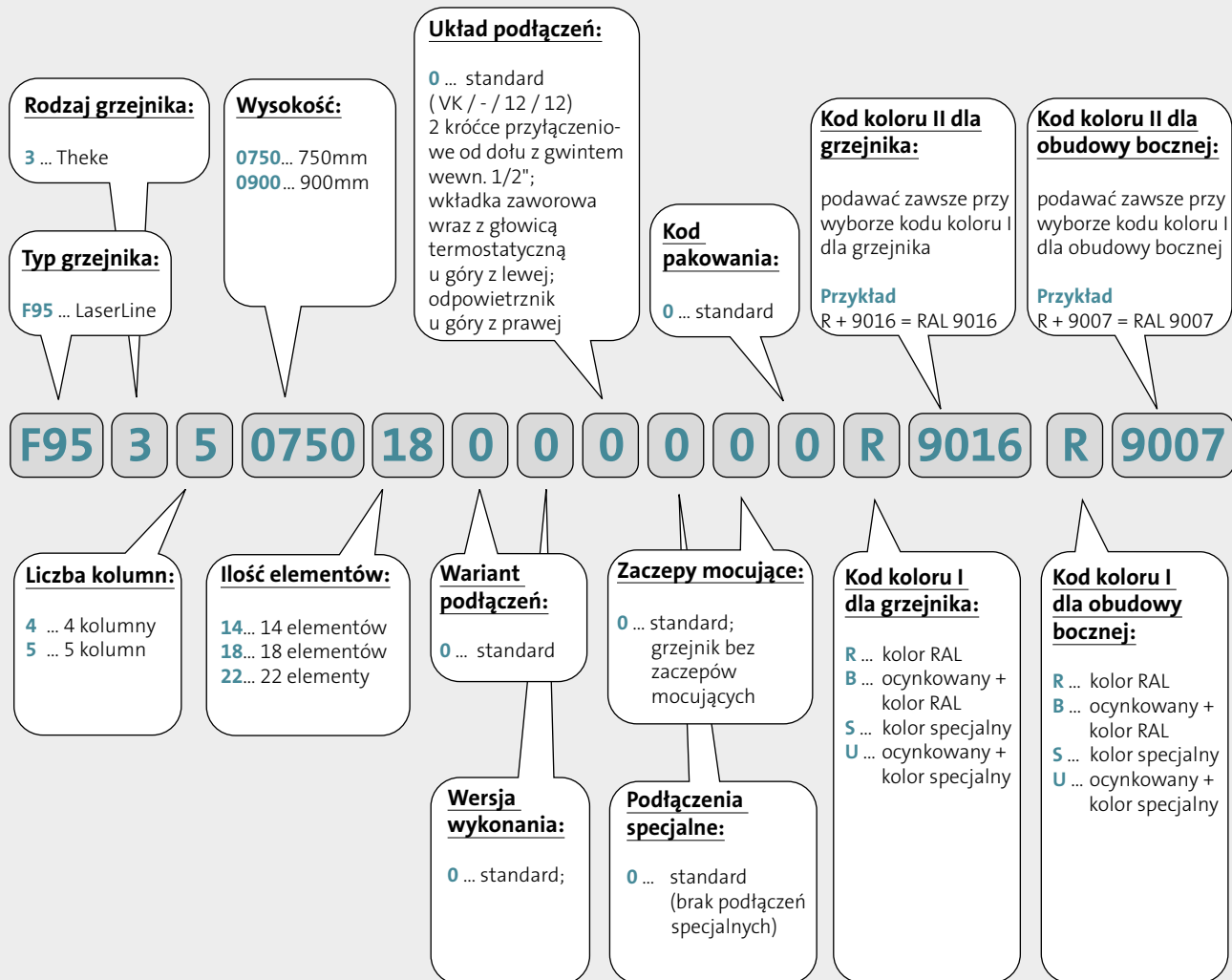

Przykładowy kod zamówienia dla grzejnika **LaserLine Theke**

- typ: LaserLine Theke
- liczba kolumn: 5
- wysokość: 750 mm
- ilość elementów: 18 (długość 900 mm)
- wariant podłączeń: standard
- układ podłączeń: standard
- wersja wykonania: standard, bez zaczepty mocujących
- kod pakowania: standard
- kolor grzejnika: RAL 9016
- kolor obudowy: RAL 9007

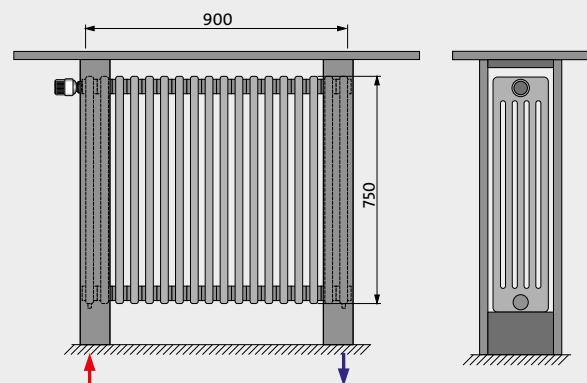

przykładowy kod zamówienia - F953507501800000R9016R9007

kody zamówieniowe

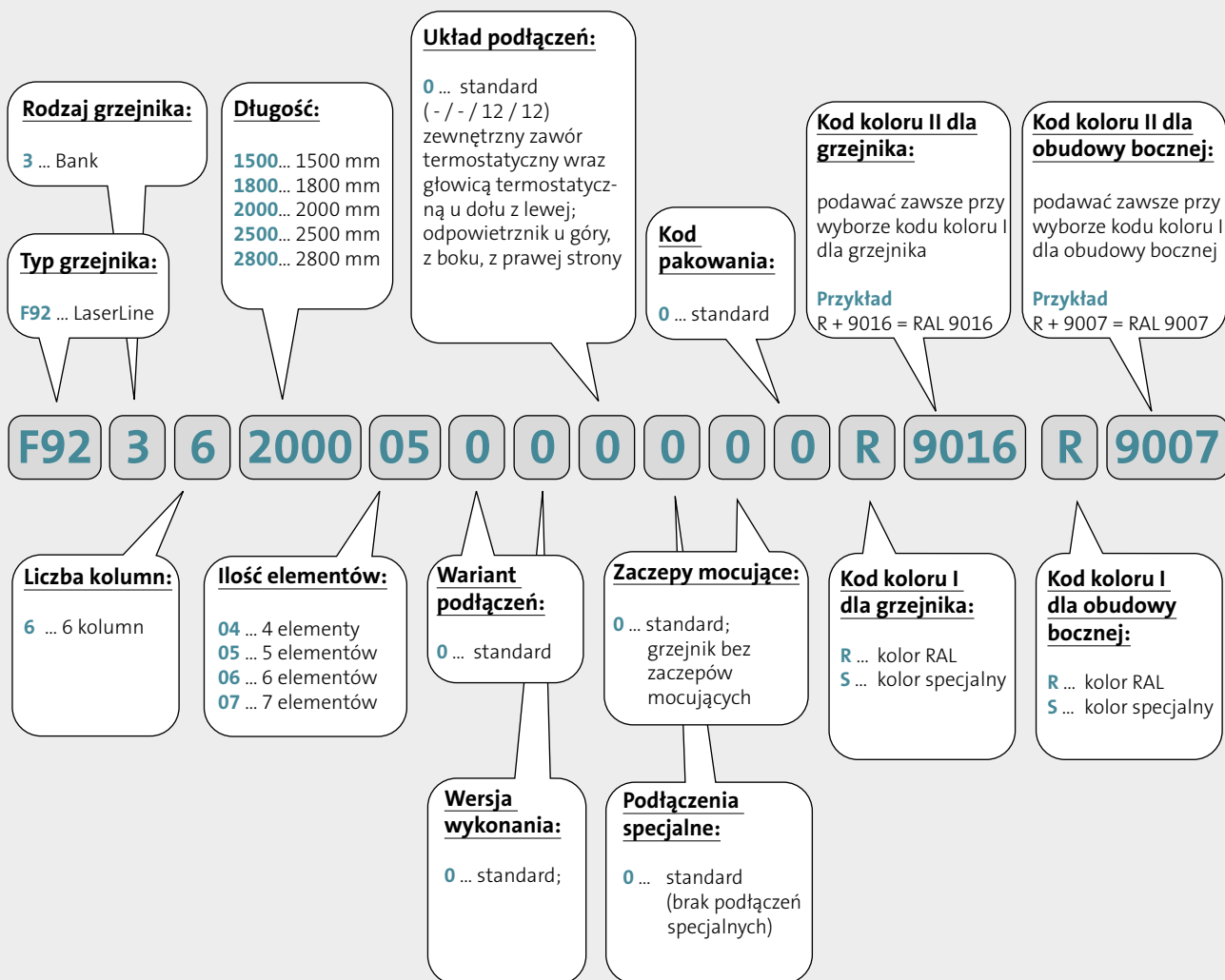

Przykładowy kod zamówienia dla grzejnika **LaserLine Bank**

- typ: LaserLine Bank
- liczba kolumn: 6
- długość: 2000 mm
- ilość elementów: 5 (wysokość 250 mm)
- wariant podłączeń: standard
- układ podłączeń: standard
- wersja wykonania: standard, bez zaczepty mocujących
- kod pakowania: standard
- kolor grzejnika: RAL 9016
- kolor obudowy: RAL 9007

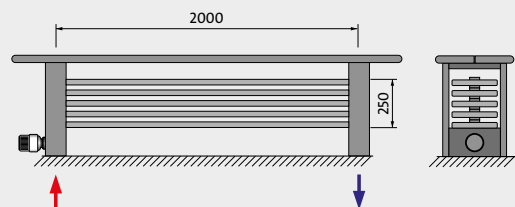

przykładowy kod zamówienia - F9236200005000000R9016R9007

KOLOR PODSTAWOWY

RAL 9016 Traffic white

KOLORY RAL

RAL 1004 Golden yellow	RAL 1012 Lemon yellow	RAL 1023 Traffic yellow	RAL 1027 Curry yellow	RAL 1033 Dahlia yellow	RAL 2003 Pastel orange	RAL 2004 Pure orange	RAL 3000 Flame red
RAL 3005 Wine red	RAL 3014 Antique pink	RAL 3015 Light pink	RAL 4002 Red violet	RAL 4007 Purple violet	RAL 4008 Signal violet	RAL 4009 Pastel violet	RAL 5001 Green blue
RAL 5002 Ultramarine blue	RAL 5009 Azure blue	RAL 5014 Pigeon blue	RAL 5015 Sky blue	RAL 5017 Traffic blue	RAL 5022 Night blue	RAL 6004 Blue green	RAL 6019 Pastel green
RAL 6033 Mint turquoise	RAL 6034 Pastel turquoise	RAL 7001 Silver grey	RAL 7013 Brown grey	RAL 7015 Slate grey	RAL 7016 Anthracite grey	RAL 7021 Black grey	RAL 7024 Graphite grey
RAL 7030 Stone grey	RAL 7035 Light grey	RAL 7037 Dusty grey	RAL 7040 Window grey	RAL 8017 Chocolate brown	RAL 8019 Grey brown	RAL 9001 Cream	RAL 9005 Jet black
RAL 9006 White aluminium	RAL 9007 Grey aluminium	RAL 9010 Pure White	RAL 040 80 05 Caffé Latte (S0222)	RAL 120 70 70 E-Green (S0221)	RAL 120 80 60 Modern green (S0220)	RAL 150 60 60 Green Apple (S0219)	RAL 250-2 Lemon Glow (S0182)
RAL 290 40 45 Mystic Purple (S0185)	RAL 290 70 20 Mauve Haze (S0178)						

KOLORY SPECJALNE

S0075 Jasmine	S0077 Magnolia	S0084 Anemone	S0087 Bahama beige	S0088 Manhattan	S0091 Pergamon	S0094 Natura	S0164 Banana
S0102 Metal Grey ²	S0104 Metal Black ²	S0141 Black Textured ¹	S0142 White Textured ¹	S0143 Light Grey	S0144 Brown Grey	S0145 Creme White	S0146 Anodic Bronze
S0147 Anodic Brown	S0148 Anodic Black	S0149 Anodic Natura	S0201 Metal Alu ²	S0074 Lakierowana stal	S0239 Patynowy brąz	RAL8029 Miedź	

¹ kolor strukturalny² kolor metaliczny

DOPLATA DO CENY GRZEJNIKA KOLOROWEGO + 20 %
DOPLATA DO CENY GRZEJNIKA ZA KOLOR SPOZA PALETY + 50%

Prezentowane kolory w formie drukowanej bądź elektronicznej należy traktować jako poglądowe. Przed zakupem należy dobierać je wyłącznie na podstawie oryginalnego wzornika kolorów.

Zmiany techniczne zastrzeżone!

PURMO GROUP POLAND SP. Z O.O.

Oddział w Wątczu
ul. Budowlanych 10, 78-600 Wątcz
Tel. 67 356 - 5101 ; -5171
marketing-pl@vogelundnoot.com
www.vogelundnoot.com.pl

